



SS2040LL

SURFACE MOUNT SCHOTTKY BARRIER RECTIFIER

VOLTAGE 40 Volt **CURRENT** 2 Ampere

FEATURES

- Surface mount package ideally suited for automatic insertion
- Low power loss, high efficiency
- Low forward voltage
- Lead free in compliance with EU RoHS 2.0
- Green molding compound as per IEC 61249 standard

MECHANICAL DATA

- Case: SOD-123FL, Plastic
- Terminals: Solderable per MIL-STD-750, Method 2026
- Approx. Weight: 0.0006 ounces, 0.0173 grams
- Polarity: Color band denotes cathode end
- Marking: R4

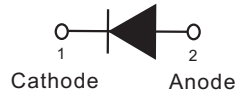

SOD-123FL Unit : inch(mm)

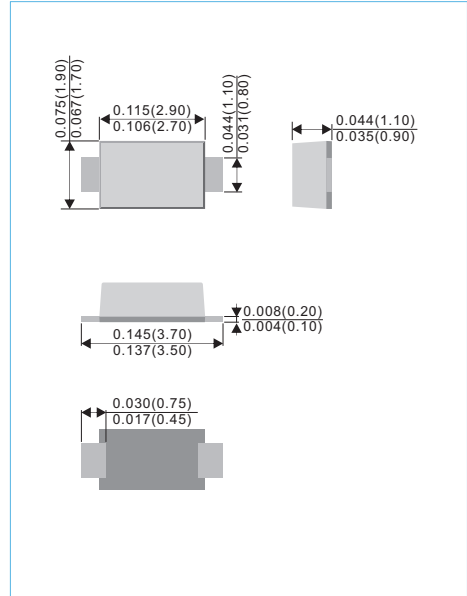

ABSOLUTE RATINGS($T_A=25^\circ\text{C}$ unless otherwise specified)

PARAMETER	SYMBOL	VALUE	UNITS
Reverse Voltage	V_R	40	V
Peak Reverse Voltage	V_{RRM}	40	V
Average Rectified Current	$I_{F(AV)}$	2	A
Non-repetitive Peak Forward Surge Current at $t=8.3\text{ms}$	I_{FSM}	50	A

ELECTRICAL AND THERMAL CHARACTERISTICS($T_A=25^\circ\text{C}$ unless otherwise specified)

PARAMETER	SYMBOL	VALUE	UNITS
Minimum Reverse Breakdown Voltage at $I_R=500\mu\text{A}$	V_R	40	V
Maximum Forward Voltage at $I_F=2.0\text{A}$	V_F	0.45	V
Reverse Leakage Current at V_{RRM}	I_R	500	μA
Typical Thermal Resistance, Junction to Ambient (Note 1)	$R_{\theta JA}$	250	$^\circ\text{C/W}$
Operating Junction and Storage Temperature Range	T_J, T_{STG}	-50 to +125	$^\circ\text{C}$

Note.1 Mounted on PCB with minimum pad layout.



SS2040LL

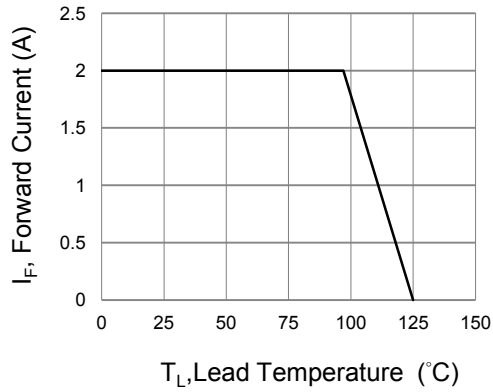

Fig.1 Forward Current Derating Curve

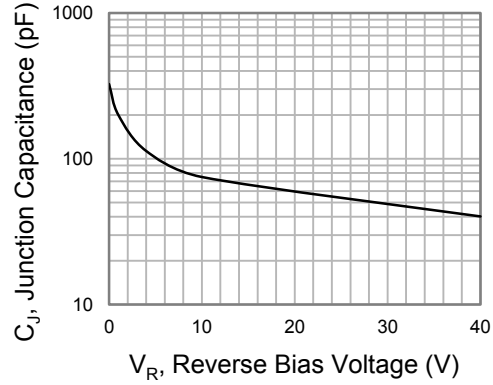

Fig.2 Typical Junction Capacitance

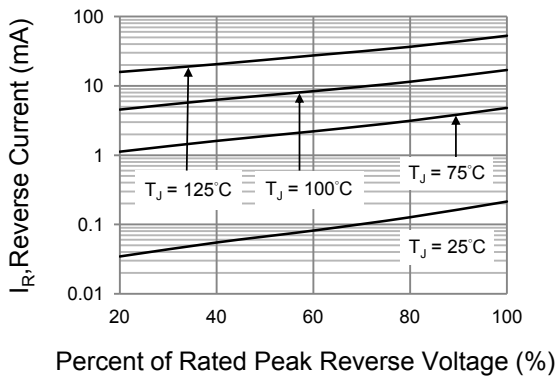

Fig.3 Typical Reverse Characteristics

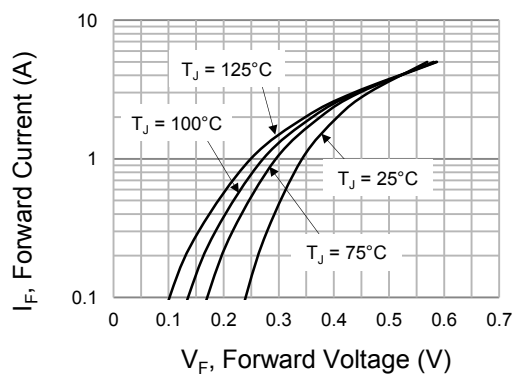

Fig.4 Typical Forward Characteristics

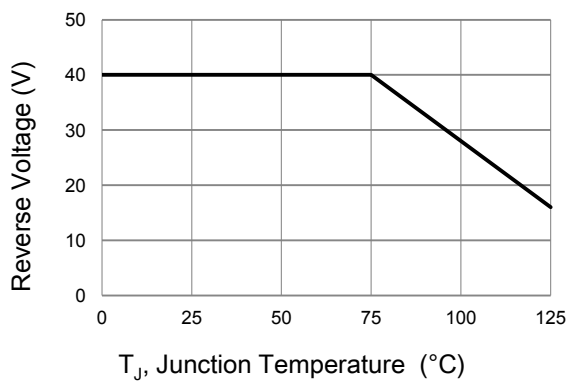

Fig.5 Operating Temperature Derating Curve



SS2040LL

MOUNTING PAD LAYOUT

SOD-123FL

Unit : inch(mm)

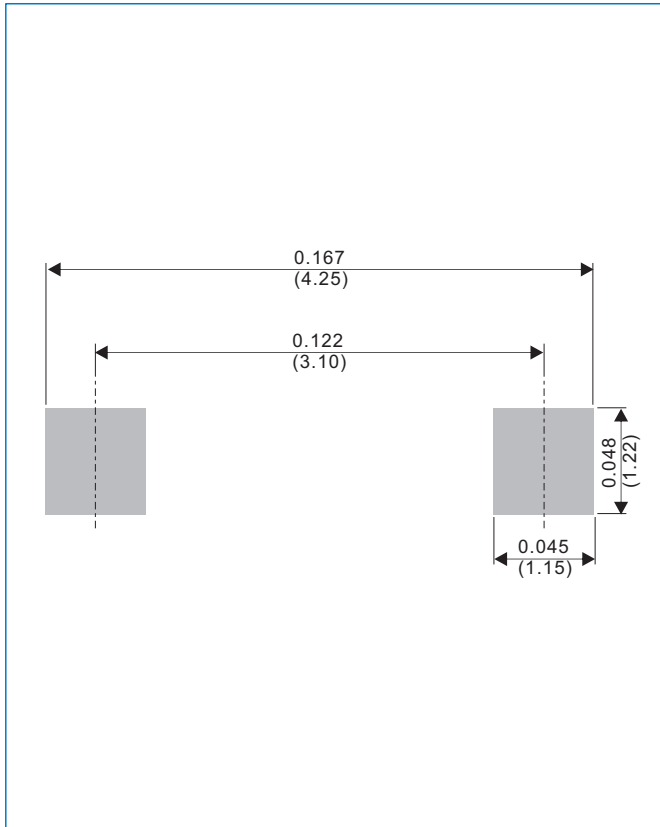

ORDER INFORMATION

- Packing information
 - T/R - 10K per 13" plastic Reel
 - T/R - 3K per 7" plastic Reel



SS2040LL

Part No_packing code_Version

SS2040LL_R1_00001

SS2040LL_R2_00001

For example :

RB500V-40 **R2** **00001**

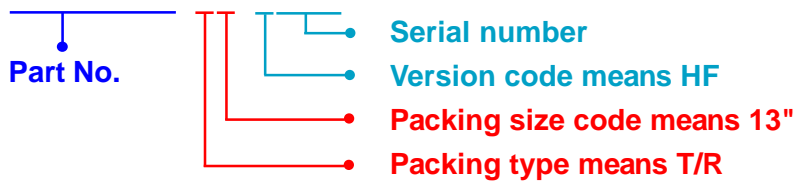

Packing Code XX				Version Code XXXXX		
Packing type	1 st Code	Packing size code	2 nd Code	HF or RoHS	1 st Code	2 nd ~5 th Code
Tape and Ammunition Box (T/B)	A	N/A	0	HF	0	serial number
Tape and Reel (T/R)	R	7"	1	RoHS	1	serial number
Bulk Packing (B/P)	B	13"	2			
Tube Packing (T/P)	T	26mm	X			
Tape and Reel (Right Oriented) (TRR)	S	52mm	Y			
Tape and Reel (Left Oriented) (TRL)	L	PANASERT T/B CATHODE UP (PBCU)	U			
FORMING	F	PANASERT T/B CATHODE DOWN (PBCD)	D			



SS2040LL

Disclaimer

- Reproducing and modifying information of the document is prohibited without permission from Panjit International Inc..
- Panjit International Inc. reserves the rights to make changes of the content herein the document anytime without notification. Please refer to our website for the latest document.
- Panjit International Inc. disclaims any and all liability arising out of the application or use of any product including damages incidentally and consequentially occurred.
- Panjit International Inc. does not assume any and all implied warranties, including warranties of fitness for particular purpose, non-infringement and merchantability.
- Applications shown on the herein document are examples of standard use and operation. Customers are responsible in comprehending the suitable use in particular applications. Panjit International Inc. makes no representation or warranty that such applications will be suitable for the specified use without further testing or modification.
- The products shown herein are not designed and authorized for equipments requiring high level of reliability or relating to human life and for any applications concerning life-saving or life-sustaining, such as medical instruments, transportation equipment, aerospace machinery et cetera. Customers using or selling these products for use in such applications do so at their own risk and agree to fully indemnify Panjit International Inc. for any damages resulting from such improper use or sale.
- Since Panjit uses lot number as the tracking base, please provide the lot number for tracking when complaining.