



**TABLE OF CONTENTS**

1.DATA SHEET

PAGE 1

2.MARKING

PAGE 5

3.TAPING

PAGE 6

4.PACKING

PAGE 7

5.HIGH RELIABILITY TEST SPEC.

PAGE 11



# AZ23C2V4 SERIES

## DUAL SURFACE MOUNT ZENER DIODES

**VOLTAGE** 2.4 to 51 Volts **POWER** 300 mWatts

SOT-23

Unit: inch ( mm )

### FEATURES

- Dual Zeners in Common Anode Configuration
- 300mW Power Dissipation Rating
- Zener Voltages from 2.4~51V
- Ideally Suited for Automatic Insertion
- Common Cathode Style Available See DZ Series
- In compliance with EU RoHS 2002/95/EC directives

### MECHANICAL DATA

- Case: SOT-23, Molded Plastic
- Terminals: Solderable per MIL-STD-750, Method 2026
- Polarity: See Diagram
- Approx. Weight: 0.008 grams
- Mounting Position: Any

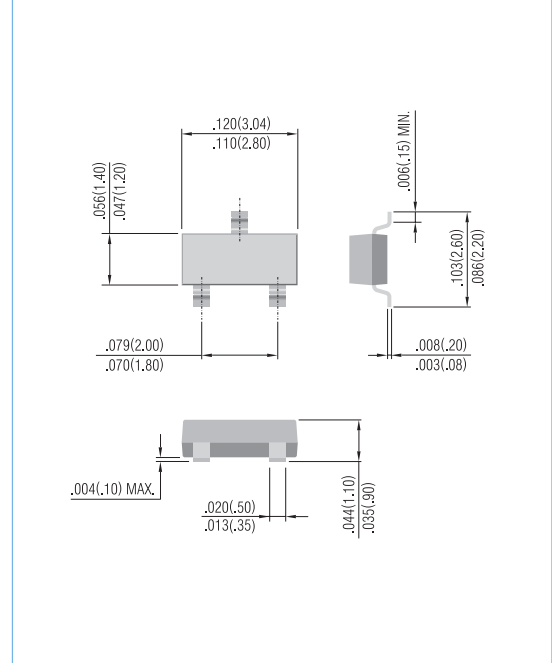

## MAXIMUM RATINGS AND ELECTRICAL CHARACTERISTICS

Parameter	Symbol	Value	Units
Power Dissipation (Note 1)	$P_D$	300	mW
Thermal Resistance, Junction to Ambient Air (Note 1)	$R_{\theta JA}$	417	$^{\circ}C/W$
Operating and Storage Temperature Range	$T_J, T_{STG}$	-55 to +150	$^{\circ}C$

### COMMON ANODE

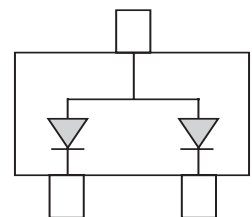

### NOTES:

- Mounted on 5.0mm<sup>2</sup>(.013mm thick) land areas.
- Measured on 8.3ms, single half sine-wave or equivalent square wave, duty cycle = 4 pulses per minute maximum.



## AZ23C2V4 SERIES

Part Number	Nominal Zener Voltage			Max. Zener Impedance				Max Reverse Leakage Current		Marking Code
	V <sub>Z</sub> @ I <sub>ZT</sub>			Z <sub>ZT</sub> @ I <sub>ZT</sub>		Z <sub>ZK</sub> @ I <sub>ZK</sub>		I <sub>R</sub> @ V <sub>R</sub>		
	Nom. V	Min. V	Max. V	Ω	mA	Ω	mA	μA	V	
AZ23C2V4	2.4	2.28	2.52	85	5.0	600	1.00	100	1.0	DO
AZ23C2V7	2.7	2.57	2.84	83	5.0	600	1.00	75	1.0	DA
AZ23C3V0	3.0	2.85	3.15	95	5.0	600	1.00	50	1.0	DB
AZ23C3V3	3.3	3.14	3.47	95	5.0	600	1.00	25	1.0	DC
AZ23C3V6	3.6	3.42	3.78	95	5.0	600	1.00	15	1.0	DD
AZ23C3V9	3.9	3.71	4.10	95	5.0	600	1.00	10	1.0	DE
AZ23C4V3	4.3	4.09	4.52	95	5.0	600	1.00	5.0	1.0	DF
AZ23C4V7	4.7	4.47	4.94	78	5.0	500	1.00	5.0	2.0	DG
AZ23C5V1	5.1	4.85	5.36	60	5.0	480	1.00	0.1	0.8	DH
AZ23C5V6	5.6	5.32	5.88	40	5.0	400	1.00	0.1	1.0	DI
AZ23C6V2	6.2	5.89	6.51	10	5.0	150	1.00	0.1	2.0	DJ
AZ23C6V8	6.8	6.46	7.14	8	5.0	80	1.00	0.1	3.0	D11
AZ23C7V5	7.5	7.13	7.88	7	5.0	80	1.00	0.1	5.0	D12
AZ23C8V2	8.2	7.79	8.61	7	5.0	80	1.00	0.1	6.0	D13
AZ23C9V1	9.1	8.65	9.56	10	5.0	100	1.00	0.1	7.0	D14
AZ23C10	10	9.50	10.50	15	5.0	150	1.00	0.1	7.5	D15
AZ23C11	11	10.45	11.55	20	5.0	150	1.00	0.1	8.5	D16
AZ23C12	12	11.40	12.60	20	5.0	150	1.00	0.1	9.0	D17
AZ23C13	13	12.35	13.65	25	5.0	170	1.00	0.1	10.0	D18
AZ23C14	14	13.30	14.70	25	5.0	170	1.00	0.1	10.5	DK
AZ23C15	15	14.25	15.75	30	5.0	200	1.00	0.1	11.0	D19
AZ23C16	16	15.20	16.80	40	5.0	200	1.00	0.1	12.0	D20
AZ23C17	17	16.15	17.85	40	5.0	200	1.00	0.1	13.0	DL
AZ23C18	18	17.10	18.90	50	5.0	225	1.00	0.1	14.0	D21
AZ23C20	20	19.00	21.00	50	5.0	225	1.00	0.1	15.0	D22
AZ23C22	22	20.90	23.10	55	5.0	250	1.00	0.1	17.0	D23
AZ23C24	24	22.80	25.20	80	5.0	250	1.00	0.1	18.0	D24
AZ23C27	27	25.65	28.35	80	5.0	300	1.00	0.1	20.0	D25
AZ23C28	28	26.60	29.40	80	5.0	300	1.00	0.1	22.0	DM
AZ23C30	30	28.50	31.50	80	5.0	300	1.00	0.1	22.5	D26
AZ23C33	33	31.35	34.65	80	5.0	325	1.00	0.1	25.0	D27
AZ23C36	36	34.20	37.80	90	5.0	350	1.00	0.1	27.0	D28
AZ23C39	39	37.05	40.95	90	5.0	350	1.00	0.1	29.0	D29
AZ23C43	43	40.85	45.15	100	5.0	375	1.00	0.1	32.0	D30
AZ23C47	47	44.65	49.35	100	5.0	375	1.00	0.1	35.0	D31
AZ23C51	51	48.45	53.55	100	5.0	400	1.00	0.1	38.0	D32



# AZ23C2V4 SERIES

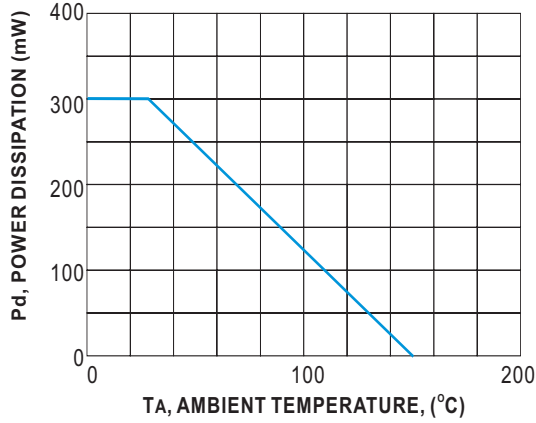

**Fig.1 POWER DERATING CURVE**

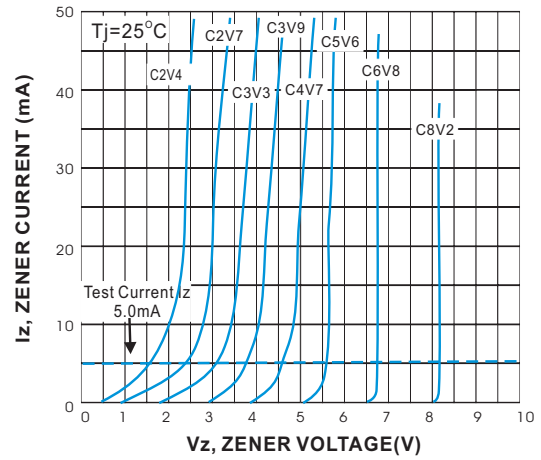

**Fig.2 ZENER BREAKDOWN CHARACTERISTICS**

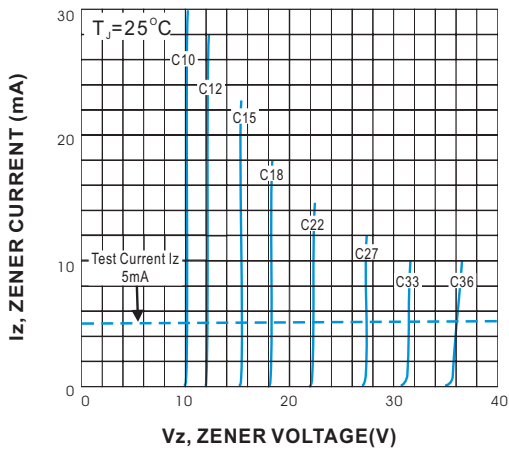

**Fig.3 ZENER BREAKDOWN CHARACTERISTICS**

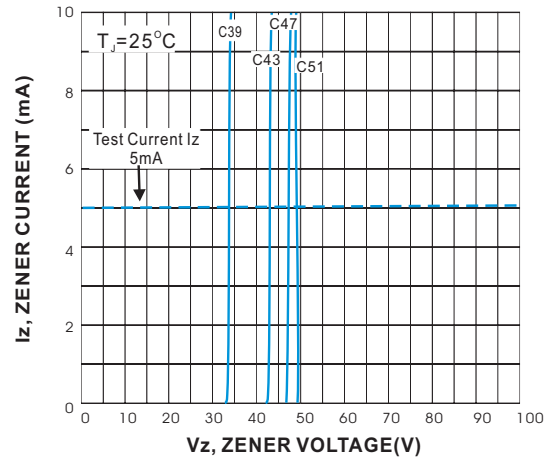

**Fig.4 ZENER BREAKDOWN CHARACTERISTICS**

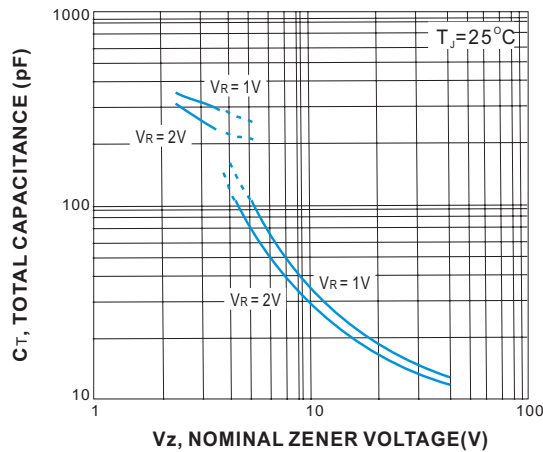
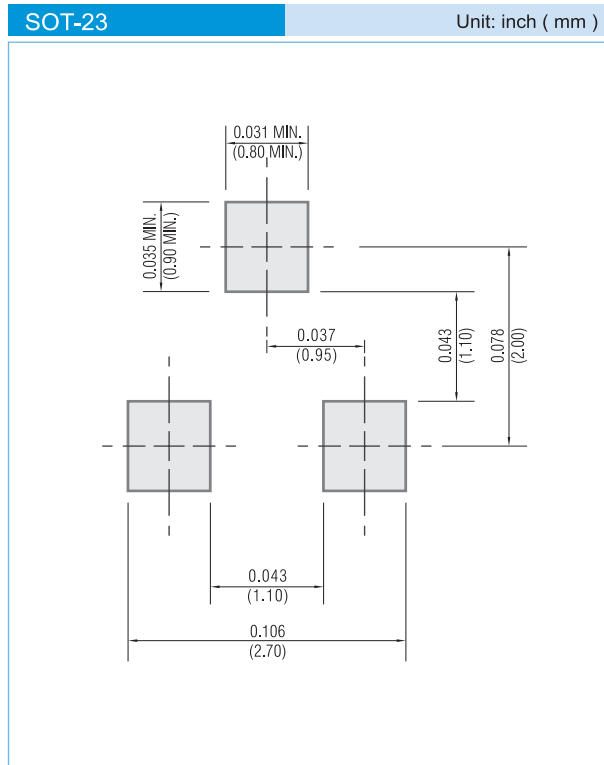

**Fig.5 TOTAL CAPACITANCE VS NOMINAL ZENER VOLTAGE**



# AZ23C2V4 SERIES

## MOUNTING PAD LAYOUT



## ORDER INFORMATION

- Packing information
  - T/R - 12K per 13" plastic Reel
  - T/R - 3K per 7" plastic Reel

## LEGAL STATEMENT

### Copyright PanJit International, Inc 2008

The information presented in this document is believed to be accurate and reliable. The specifications and information herein are subject to change without notice. Pan Jit makes no warranty, representation or guarantee regarding the suitability of its products for any particular purpose. Pan Jit products are not authorized for use in life support devices or systems. Pan Jit does not convey any license under its patent rights or rights of others.



## 2. MARKING

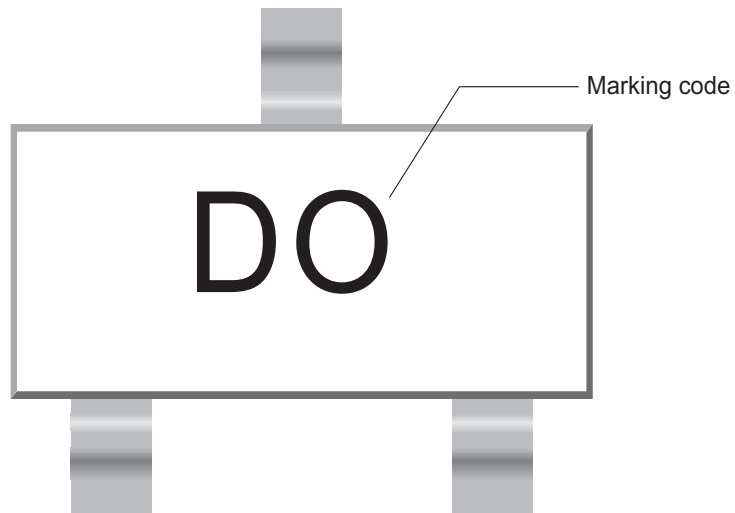



### 3. TAPING

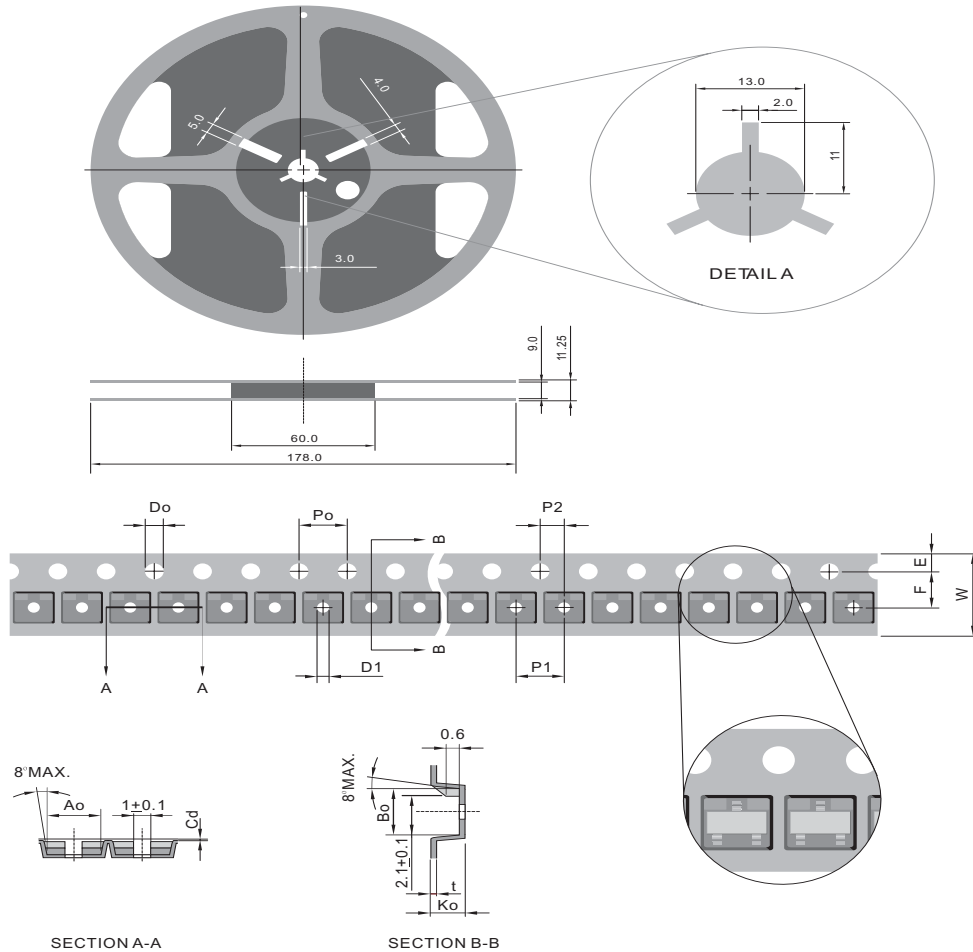

SYMBOL	mm (INCH)
TYPE SIZE	8.00 (0.314)
Ao	3.15 ± 0.10(0.124 ± 0.004)
Bo	2.65 ± 0.10(0.104 ± 0.004)
Do	1.55 ± 0.05(0.610 ± 0.002)
D1	1.00 ± 0.10(0.039 ± 0.004)
E	1.75 ± 0.10(0.069 ± 0.004)
F	3.50 ± 0.05(0.137 ± 0.002)
Ko	1.17 ± 0.10(0.046 ± 0.004)
Po	4.00 ± 0.10(0.157 ± 0.004)
P1	4.00 ± 0.10(0.157 ± 0.004)
P2	2.00 ± 0.05(0.009 ± 0.002)
t	0.20 ± 0.05(0.008 ± 0.002)
W	8.00 ± 0.30(0.314 ± 0.012)
Ao'	3.00 ± 0.10(0.118 ± 0.004)
Bo'	2.55 ± 0.10(0.100 ± 0.004)

**NOTE:**

1. There shall be leader of 230 mm minimum which may consist of carrier and or cover tape follower by a minimum of 160 mm of carrier tape sealed with cover tape.
2. There shall e minimum of 160 mm of empty component pockets sealed with cover tape.
3. Devices are packed in accordance whit EIA standard EIA-481-A and specifications given above.



## 4. PACKING

### REEL PACKING

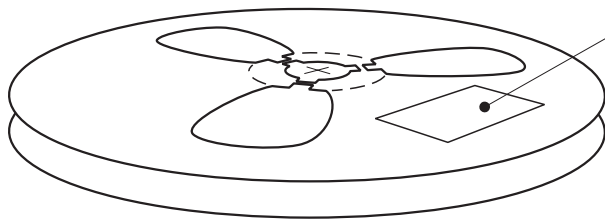

Quantity per Reel: 3,000 pcs

#### LABEL TYPE

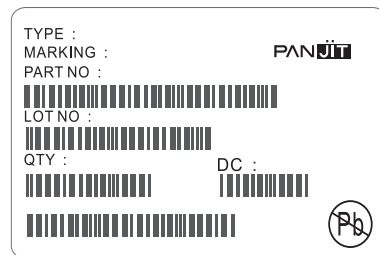

### CARTON

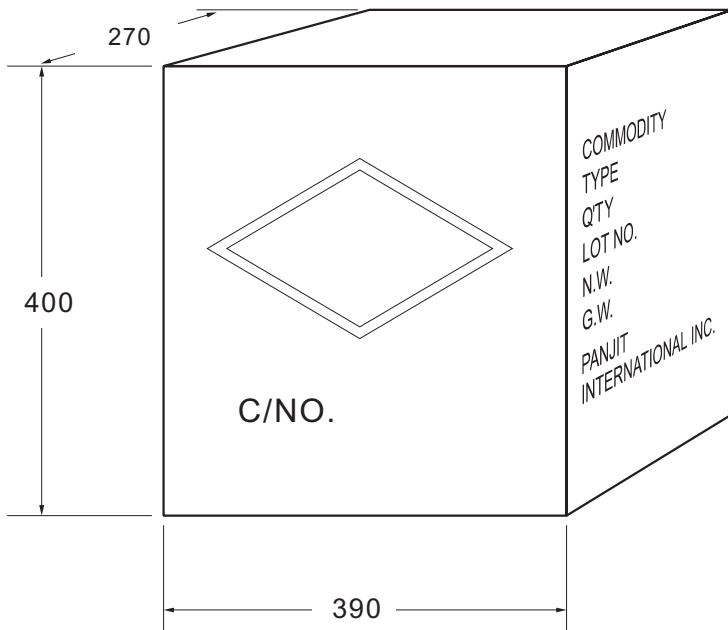

Box Dimensions : mm  
Quantity per Box: 240,000pcs

#### SHIPPING MARK

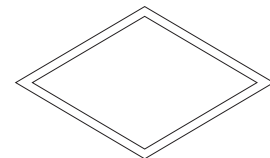

C/NO.  
PRODUCT COUNTRY

#### SIDE MARK

COMMODITY:  
TYPE:  
Q'TY:  
LOT NO.  
N.W.  
G.W.  
PANJIT  
INTERNATIONAL INC.





## Bulk Packing

PACKAGE	INNER BOX SIZE	BOX	CARTON SIZE	CARTON	APPROX. GROSS WEIGHT
	(m/m)	(EA)	(m/m)	(EA)	(Kg)
<b>Bulk Packing</b>					
A-405	198 x 84 x 20	1,000	459 x 214 x 256	50,000	18.2
AG / RB-20 / WOB	258 x 190 x 77	1,000	395 x 270 x 400	10,000	17
AM	258 x 190 x 77	1,000	395 x 270 x 400	10,000	15
CM / KBPC	193 x 193 x 46	50	405 x 210 x 265	500	17
CMW / KBPC-W	193 x 193 x 46	25	405 x 210 x 265	250	8.5
KBPC-P / CP-15 / 25 / 35 / 50	193 x 193 x 46	50	405 x 210 x 265	500	12
KBPC-PW / CPW-15 / 25 / 35 / 50	193 x 193 x 46	25	405 x 210 x 265	250	6
CP-3 / 6	219 x 115 x 90	200	600 x 235 x 198	2,000	7.3/8.8
CP-8 / 10	219 x 115 x 90	200	600 x 235 x 198	2,000	13.8
DIP	-	-	495 x 214 x 256	12,000	9
DO-15	200 x 85 x 25	1,000	459 x 214 x 256	40,000	20.2
DO-201AD	200 x 85 x 40	500	495 x 214 x 256	12,500	15.8
DO-201AE	200 x 85 x 40	500	495 x 214 x 256	12,500	15.9
DO-34	96 x 80 x 42	2,000	410 x 335 x 265	120,000	14.4
DO-35	96 x 80 x 42	2,000	410 x 335 x 265	120,000	17.4
DO-41	198 x 84 x 20	1,000	459 x 214 x 265	50,000	19.4
DO-41G	96 x 80 x 42	1,000	410 x 335 x 265	60,000	18
FL	230 x 230 x 50	500	495 x 245 x 180	3,000	18.4
FI	488 x 150 x 100	1,200	510 x 340 x 235	24,000	18
GBJ (TUBE)	556 x 150 x 100	800	578 x 340 x 235	3,200	25.4
GBJ (BOX)	350 x 337 x 44	600	375 x 360 x 213	2,400	14.4
GBL	350 x 337 x 44	960	375 x 360 x 213	3,840	13.1
GBP	350 x 337 x 44	1,120	375 x 360 x 213	4,480	10.9
GBPC	193 x 193 x 46	50	405 x 210 x 265	500	17
GBPCW	193 x 193 x 46	25	405 x 210 x 265	250	8.5
GBU (TUBE)	488 x 150 x 100	800	510 x 310 x 235	3,200	23.2
GBU (BOX)	350 x 337 x 44	800	375 x 360 x 213	3,200	16.9
GL	195 x 195 x 40	80	460 x 215 x 260	800	11
GPJ	500 x 150 x 145	750	572 x 306 x 218	1,500	17
KBJ	221 x 176 x 45	200	376 x 263 x 241	2,000	15
KBPF	242 x 208 x 35	500	426 x 252 x 365	10,000	19.2
KBU	276 x 158 x 59	200	493 x 287 x 320	3,000	24
MDI	350 x 337 x 44	6,000	375 x 360 x 390	48,000	14.4
P-600	208 x 90 x 83	500	459 x 214 x 256	5,000	12.1
R-1	198 x 84 x 20	1,000	459 x 214 x 256	50,000	11.8
SDIP	-	-	495 x 214 x 256	24,000	12.4
TO-220	540 x 145 x 82	2,000	555 x 306 x 188	8,000	22
ITO-220	540 x 145 x 82	2,000	555 x 306 x 188	8,000	19.6
TO-251AB	555 x 145 x 95	8,400	572 x 306 x 218	33,600	22
TO-3P / TO-247AD	-	-	536 x 243 x 100	1,500	13
KBL	230 x 147 x 50	200	460 x 245 x 275	3,000	17.25
K3 / K6	219 x 115 x 90	200	600 x 235 x 198	2,000	7.3/8.8
K8	210 x 115 x 90	200	600 x 235 x 198	2,000	13.8



## Reel Packing

PACKAGE	REEL SIZE (inch)	REEL (pcs)	COMPONENT SPACE (m/m)	TAPE SPACE (m/m)	REEL DIA (m/m)	CARTON SIZE (m/m)	CARTON (EA)	APPROX. GROSS WEIGHT (Kg)
<b>Reel Packing</b>								
R-1	-	5,000	5.0	52	330	340 x 340 x 410	25,000	7.9
A-405	-	5,000	5.0	52	330	340 x 340 x 410	25,000	11.3
DO-15	-	4,000	5.0	52	330	340 x 340 x 410	20,000	11
DO-201AD	-	1,250	10.0	52	330	340 x 340 x 410	6,250	9.6
DO-201AE	-	1,250	10.0	52	330	340 x 340 x 410	6,250	9.6
DO-34	15	10,000	5.0	52	360	360 x 360 x 395	50,000	9.5
DO-35	15	10,000	5.0	52	360	360 x 360 x 395	50,000	11.4
DO-41	-	5,000	5.0	52	330	340 x 340 x 410	25,000	11.8
DO-41G	15	5,000	5.0	52	360	360 x 360 x 395	25,000	11.3
P-600	-	800	10.0	52	330	340 x 340 x 410	4,000	10
DPAK/TO-252	13	3,000	8.0	16	330	375 x 360 x 390	42,000	20.1
D2PAK/TO-263	13	800	16.0	24	330	375 x 360 x 390	6,400	14.7
MDI	13	3,000	8.0	12	330	375 x 360 x 390	48,000	14.6
SDIP	13	1,500	12.0	16	330	375 x 360 x 390	21,000	14.9
QUADRO-MELF	7	2,500	4.0	-	178	385 x 380 x 260	200,000	13.5
MELF/DL-41	13	5,000	4.0	-	330	360 x 360 x 395	200,000	23.4
MICRO-MELF	7	2,500	4.0	-	178	385 x 380 x 260	200,000	9.1
MINI-MELF	13	10,000	4.0	-	330	360 x 360 x 395	200,000	14.8
MINI-MELF	7	2500	4.0	-	178	385 x 380 x 260	120,000	13
SMA	13	7,500	4.0	12	330	375 x 360 x 390	120,000	17.5
SMA	7	1,800	4.0	12	178	390 x 240 x 420	72,000	10
SMB	13	3,000	8.0	12	330	375 x 360 x 390	48,000	13.6
SMB	7	500	8.0	12	178	390 x 240 x 420	20,000	6.5
SMC	13	3,000	8.0	16	330	375 x 360 x 390	42,000	18.4
SMC	7	500	8.0	16	178	390 x 240 x 420	15,000	8.5
SOD-123	13	10,000	4.0	8	330	375 x 360 x 213	120,000	6.4
SOD-123	7	3,000	4.0	8	178	390 x 270 x 400	240,000	9.4
SOD-123FL	13	10,000	4.0	8	330	375 x 360 x 213	120,000	6.4
SOD-123FL	7	3,000	4.0	8	178	390 x 270 x 400	240,000	9.4
SOD-323	13	12,000	4.0	8	330	375 x 360 x 213	144,000	10
SOD-323	7	5,000	4.0	8	178	390 x 270 x 400	400,000	15.2
SOD-523	13	12,000	4.0	8	330	375 x 360 x 213	144,000	10
SOD-523	7	5,000	4.0	8	178	390 x 270 x 400	400,000	15.2
SOT-23	13	12,000	4.0	8	330	375 x 360 x 213	144,000	6.4
SOT-23	7	3,000	4.0	8	178	390 x 270 x 400	240,000	9.4
SOT-323	13	12,000	4.0	8	330	375 x 360 x 213	144,000	6.4
SOT-323	7	3,000	4.0	8	178	390 x 270 x 400	240,000	9.4
SOT-363	13	10,000	4.0	8	330	375 x 360 x 213	120,000	7.1
SOT-363	7	3,000	4.0	8	178	390 x 270 x 400	240,000	10.2
SOT-353	13	10,000	4.0	8	330	375 x 360 x 213	120,000	7.2
SOT-353	7	3,000	4.0	8	178	390 x 270 x 400	240,000	10
SOT23-6L	13	10,000	4.0	8	330	375 x 360 x 213	120,000	7.9
SOT23-6L	7	3,000	4.0	8	178	390 x 270 x 400	240,000	14.5
SOT-143	13	10,000	4.0	8	330	375 x 360 x 213	120,000	7
SOT-143	7	3,000	4.0	8	178	390 x 270 x 400	240,000	12.8
QFN 1.2 x 1.5	7	3,000	4.0	8	178	390 x 270 x 400	240,000	7.1
QFN 1.6 x 1.6	7	4,000	4.0	8	178	390 x 240 x 420	200,000	7.8
QFN 2.0 x 2.0	7	3,000	4.0	8	178	390 x 270 x 400	240,000	7.1
SOIC-08	13	3,000	8.0	12	330	375 x 360 x 390	48,000	14.2



## Ammunition Packing

PACKAGE	AMMO	COMPONENT SPACE	TAPE SPACE	INNER BOX SIZE	CARTON SIZE	CARTON	APPROX. GROSS WEIGHT
	(pcs)	(m/m)	(m/m)	(m/m)	(m/m)	(EA)	(Kg)
<b>Ammunition Packing</b>							
A-405	5,000	5	26	255 x 47 x 150	339 x 276 x 330	60,000	12.4
A-405	5,000	5	52	255 x 75 x 150	339 x 276 x 330	40,000	16
DO-15	3,000	5	52	255 x 75 x 150	339 x 276 x 330	24,000	12.9
DO-201AD	1,250	10	52	255 x 47 x 122	339 x 276 x 330	10,000	13.3
DO-201AE	1,250	10	52	255 x 47 x 122	339 x 276 x 330	10,000	13.3
DO-34	5,000	5	26	248 x 80 x 48	406 x 335 x 257	150,000	14.7
DO-34	5,000	5	52	248 x 80 x 75	406 x 335 x 257	100,000	12.4
DO-35	5,000	5	26	248 x 80 x 48	406 x 335 x 257	150,000	16.7
DO-35	5,000	5	52	248 x 80 x 75	406 x 335 x 257	100,000	15
DO-41	5,000	5	52	255 x 75 x 150	339 x 276 x 330	40,000	16.6
DO-41G	2,500	5	26	248 x 80 x 48	406 x 335 x 257	75,000	22.7
DO-41G	2,500	5	52	248 x 80 x 75	406 x 335 x 257	50,000	15.7
P-600	400	10	52	255 x 47 x 122	339 x 276 x 330	3,200	7.8
R-1	3,000	5	26	255 x 47 x 73	310 x 268 x 170	36,000	6.8
R-1	3,000	5	52	256 x 73 x 73	310 x 268 x 170	24,000	6.2
R-1	5,000	5	52	255 x 73 x 122	339 x 276 x 274	40,000	10.1



## 5. HIGH RELIABILITY TESTING SPEC.

NO	TEST ITEM	TEST CONDITION	REFERENCE DOCUMENT	LOT QUALITY LEVEL	REMARK
1	TEMPERATURE CYCLING (T.C.T)	Ta = -55 +0, -3 °C 10min Ta = + 150 + / - °C 10min FOR 20 CYCLE	MIL - STD - 750D METHOD - 1051.5	LTPD 10 S.s. = 22 ACCEPT FOR 0 FAILURE ONLY.	
2	HIGH TEMPERATURE STORAGE LIFE (H.T.S.L)	Ta = 150 + / - 5 °C TESTING TIME: 168 HRS 500 HRS	MIL-STD-750D METHOD-1031.2	LTPD10 S.s. = 22 ACCEPT FOR 0 FAILURE ONLY.	
3	SOLDERABILITY TEST	TEMPERATURE OF SOLDER POT = 245 + / - 5 °C TIME FOR DIPPING FLUX = 5 -10 SEC TIME FOR DIPPING IN SOLDER = 5 + / - 0.5 SEC DIPPING DEPTH = 0.05 inch max FOR ONE CYCLE	MIL-STD-750D	METHOD-2026.10 LTPD 7 S.s. = 32 ACCEPT FOR 0 FAILURE ONLY.	
4	HIGH TEMPERATURE REVERSE BIAS (H.T.R.B)	Ta = 150 + / - 5 °C VR = 80 % VR ( CUSTOM SECP ) TESTING TIME: 168 HRS 500 HRS	MIL-STD-750D METHOD-1038.3	LTPD10 S.s. = 22 ACCEPT FOR 0 FAILURE ONLY.	
5	CONTINUE FORWARD OPERATING LIFE (C.F.O.L)	Ta = 55 °C I = IO + / -10 % TESTING TIME: 168 HRS 500 HRS	MIL-STD-750D METHOD-1027.3	LTPD10 S.s. = 22 ACCEPT FOR 0 FAILURE ONLY.	
6	THERMAL SHOCK (T.S.T)	HOT TANK T = 100 °C + 10 / -2 °C t = 5 min COLD TANK T = 0 °C + 2 / -10 °C t = 5 min 15 CYCLE TIME BETWEEN TRANSFERRING DO'NOT EXCEED 10 SECOND.	MIL-STD-750D METHOD-1056.7	LTPD10 S.s. = 22 ACCEPT FOR 0 FAILURE ONLY.	
7	PRESSURE COOKER (P.C.T)	Ta = 121 °C P = 1.2 kg / cm <sup>2</sup> TIME = 96 HRS	JEDEC JESD22-A102-C	LTPD10 S.s. = 22 ACCEPT FOR 0 FAILURE ONLY.	
8	INTERMITTENT FORWARD OPERATING LIFE (I.F.O.L)	I = Io x 1.0 POWER ON : 30 SEC POWER OFF : 50 SEC TESTING TIME: 2000 CYCLES	MIL-STD-750D METHOD 1036.3	LTPD10 S.s. = 22 ACCEPT FOR 0 FAILURE ONLY.	
9	FORWARD SURGE CURRENT (I.F.S.M)	SQ WAVE OR SINE WAVE IFSM=DATE SHEET SPEC. TIME = 8.3 Msec T = 1 CYCLE	MIL-STD-750D METHOD 4066.3	LTPD10 S.s. = 22 ACCEPT FOR 0 FAILURE ONLY.	
10	HUMIDITY	Ta = 85 °C RH = 85 % TESTING TIME: 168 HRS 500 HRS	MIL-STD-750D METHOD 1021.1	LTPD10 S.s. = 22 ACCEPT FOR 0 FAILURE ONLY.	
11	SOLDERABILITY RESISTANCE	TEMPERATURE OF SOLDER POT = 260 + / - 5 °C TIME FOR DIPPING IN SOLDER = 10 + 2 / - 0 SEC DIPPING DEPTH = 1.57 + / 0.79 mm BELOW BODY FOR ONE CYCLE	MIL-STD-750D METHOD 2031.1	LTPD10 S.s. = 22 ACCEPT FOR 0 FAILURE ONLY.	

SCHOTTKY PRODUCT TESTING TEMPERATURE 100 °C +/- 5°C MAX(NORMAL)