



# PJSD05CTS

## BI-DIRECTIONAL ESD PROTECTION DIODE

This Penta has been designed to Protect Sensitive Equipment against ESD and to prevent Latch-Up events in CMOS circuitry operating at 5Vdc and below. This offers an integrated solution to protect up to data line where the board space is a premium.

### SPECIFICATION FEATURES

- 100W Power Dissipation (8/20µs Waveform)
- Low Leakage Current, Maximum of 0.5µA@3.5Vdc
- Very low Clamping voltage
- IEC 61000-4-2 ESD 15kV air, 8kV Contact Compliance
- Lead free in compliance with EU RoHS2.0 (2011/65/EU & 2015/865/EU directive)
- Green molding compound as per IEC61249 Std. . (Halogen Free)

### APPLICATIONS

- Video I/O ports protection
- Set Top Boxes
- Portable Instrumentation
- Case : SOD-523 plastic
- Terminals : Solderable per MIL-STD-750, Method 2026
- Approx Weight : 0.0001 ounces, 0.0014 grams
- Marking : RS

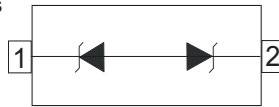
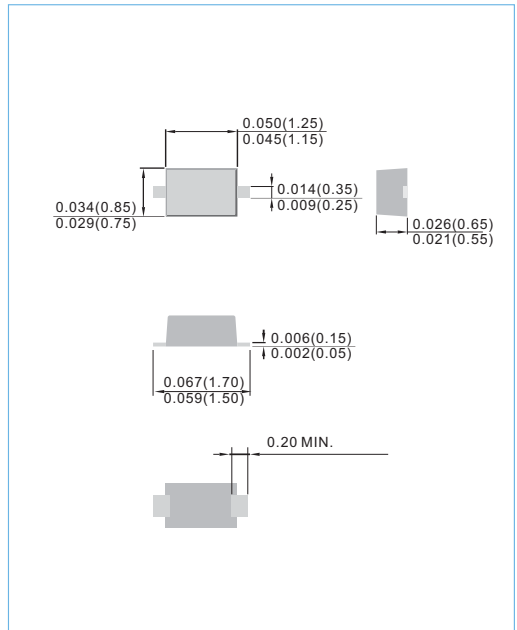

Fig.130

### SOD-523

Unit : inch(mm)



### MAXIMUM RATINGS

Rating	Symbol	Value	Units
Peak Pulse Power (8/20 µs Waveform)	P <sub>PP</sub>	100	W
Peak Pulse Current (8/20 µs Waveform)	I <sub>PP</sub>	5.0	A
ESD Voltage (HBM)	V <sub>ESD</sub>	>25	kV
Operating Junction and Storage Temperature Range	T <sub>J</sub> , T <sub>STG</sub>	-55 to 150	°C

### ELECTRICAL CHARACTERISTICS (T<sub>A</sub>=25°C)

Parameter	Symbol	Conditions	Min.	Typ.	Max.	Units
Reverse Stand-Off Voltage	V <sub>WRM</sub>		-	-	5.0	V
Reverse Breakdown Voltage	V <sub>BR</sub>	I <sub>BR</sub> =1mA	5.78	-	7.82	V
Reverse Leakage Current	I <sub>R</sub>	V <sub>R</sub> =3.5V	-	-	0.5	µA
Clamping Voltage (8/20µs)	V <sub>C</sub>	I <sub>PP</sub> =1A	-	-	12	V
Clamping Voltage (8/20µs)	V <sub>C</sub>	I <sub>PP</sub> =4A	-	-	15	V
Off State Junction Capacitance	C <sub>J</sub>	0 Vdc Bias f=1MHz	-	-	30	pF
Off State Junction Capacitance	C <sub>J</sub>	5 Vdc Bias f=1MHz	-	-	25	pF



# PJSD05CTS

## TYPICAL CHARACTERISTICS

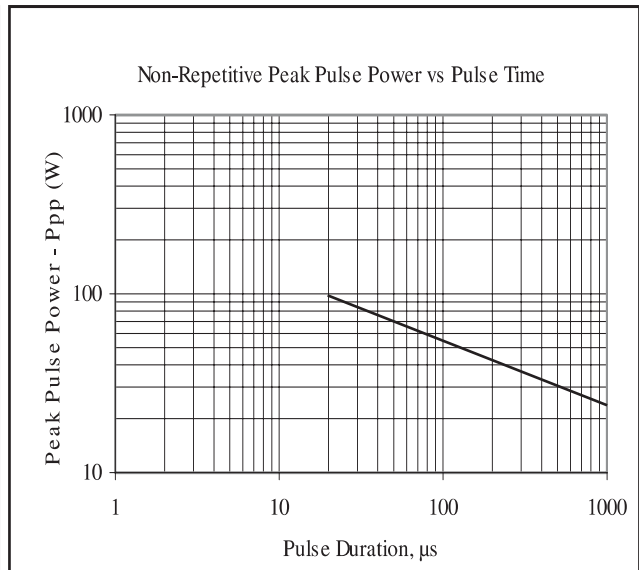
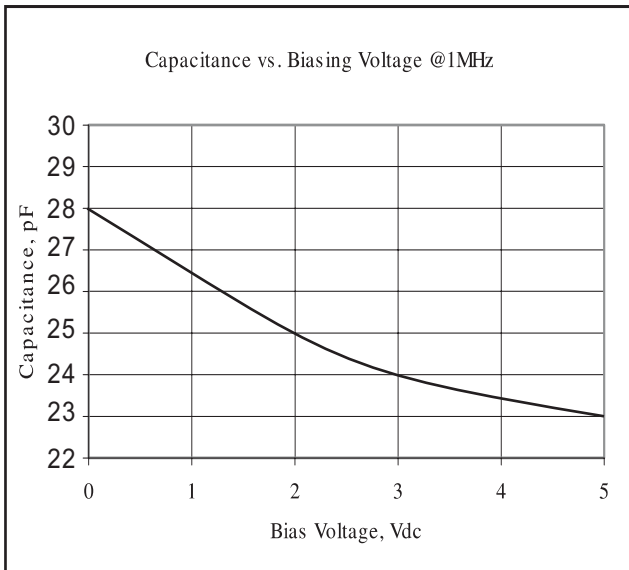
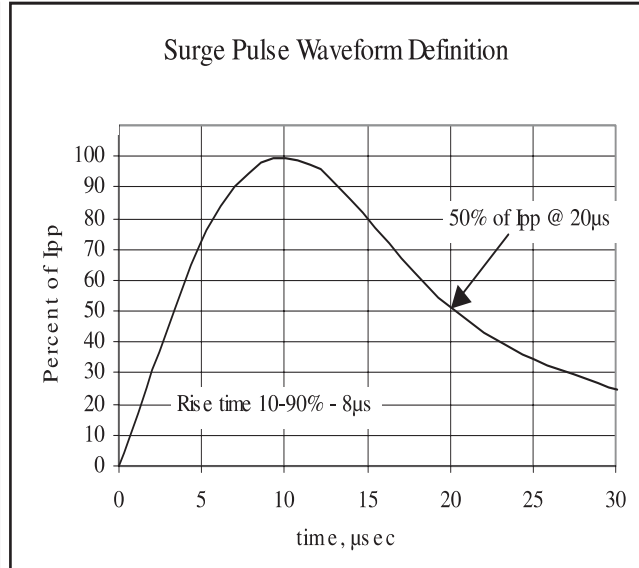
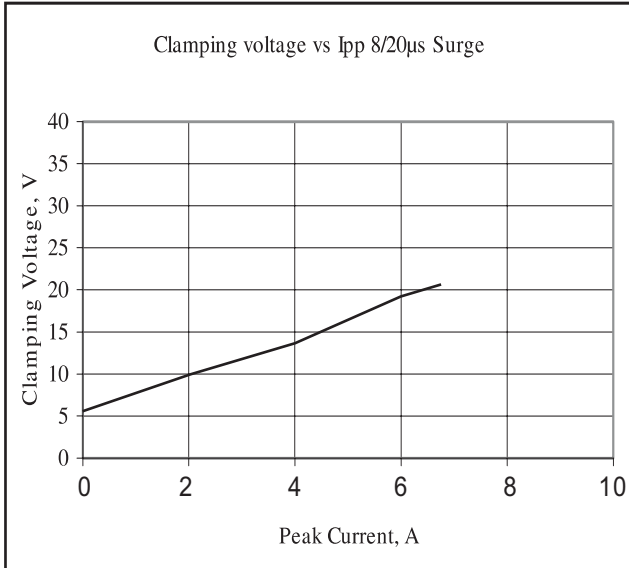



# PJSD05CTS

## MOUNTING PAD LAYOUT

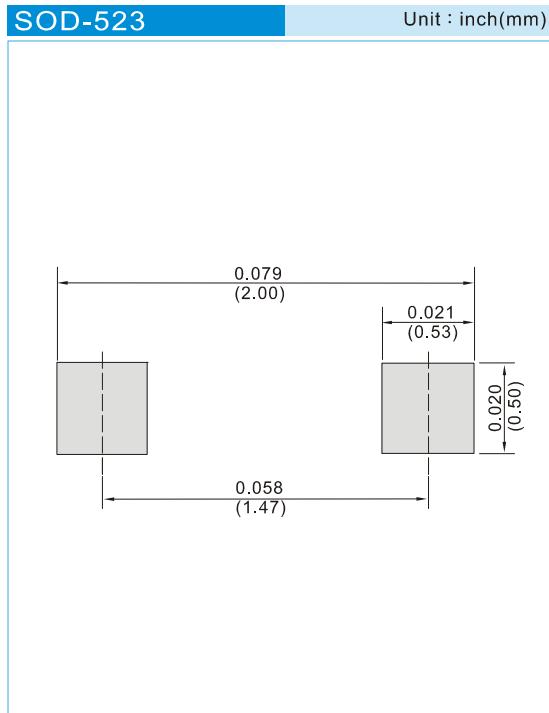

## ORDER INFORMATION

- Packing information
  - T/R - 12K per 13" plastic Reel
  - T/R - 5K per 7" plastic Reel



# PJSD05CTS

## Part No\_packing code\_Version

PJSD05CTS\_R1\_00001

PJSD05CTS\_R2\_00001

For example :

**RB500V-40\_R2\_00001**

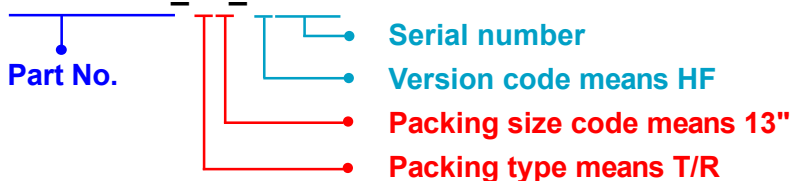

Packing Code <b>XX</b>				Version Code <b>XXXXX</b>		
Packing type	1 <sup>st</sup> Code	Packing size code	2 <sup>nd</sup> Code	HF or RoHS	1 <sup>st</sup> Code	2 <sup>nd</sup> ~5 <sup>th</sup> Code
Tape and Ammunition Box (T/B)	A	N/A	0	HF	0	serial number
Tape and Reel (T/R)	R	7"	1	RoHS	1	serial number
Bulk Packing (B/P)	B	13"	2			
Tube Packing (T/P)	T	26mm	X			
Tape and Reel (Right Oriented) (TRR)	S	52mm	Y			
Tape and Reel (Left Oriented) (TRL)	L	PANASERT T/B CATHODE UP (PBCU)	U			
FORMING	F	PANASERT T/B CATHODE DOWN (PBCD)	D			



## PJSD05CTS

### Disclaimer

- Reproducing and modifying information of the document is prohibited without permission from Panjit International Inc..
- Panjit International Inc. reserves the rights to make changes of the content herein the document anytime without notification. Please refer to our website for the latest document.
- Panjit International Inc. disclaims any and all liability arising out of the application or use of any product including damages incidentally and consequentially occurred.
- Panjit International Inc. does not assume any and all implied warranties, including warranties of fitness for particular purpose, non-infringement and merchantability.
- Applications shown on the herein document are examples of standard use and operation. Customers are responsible in comprehending the suitable use in particular applications. Panjit International Inc. makes no representation or warranty that such applications will be suitable for the specified use without further testing or modification.
- The products shown herein are not designed and authorized for equipments requiring high level of reliability or relating to human life and for any applications concerning life-saving or life-sustaining, such as medical instruments, transportation equipment, aerospace machinery et cetera. Customers using or selling these products for use in such applications do so at their own risk and agree to fully indemnify Panjit International Inc. for any damages resulting from such improper use or sale.
- Since Panjit uses lot number as the tracking base, please provide the lot number for tracking when complaining.