



**TABLE OF CONTENTS**

1.DATA SHEET

PAGE 1

2.MARKING

PAGE 6

3.TAPING

PAGE 7

4.PACKING

PAGE 8

5.HIGH RELIABILITY TEST SPEC.

PAGE 12



# BAT54TB/ATB/CTB/RTB/STB

## SURFACE MOUNT SCHOTTKY BARRIER

**VOLTAGE** 30 Volts    **CURRENT** 0.2 Amperes

**SOT-523**

Unit : inch(mm)

### FEATURES

- Low turn-on voltage
- Fast switching
- PN Junction Guard Ring for Transient and ESD Protection.
- Lead free in comply with EU RoHS 2002/95/EC directives.
- Green molding compound as per IEC61249 Std. . (Halogen Free)

### MECHANICAL DATA

Case: SOT-523, Plastic

Terminals: Solderable per MIL-STD-750, Method 2026

Approx. Weight: 0.002 gram

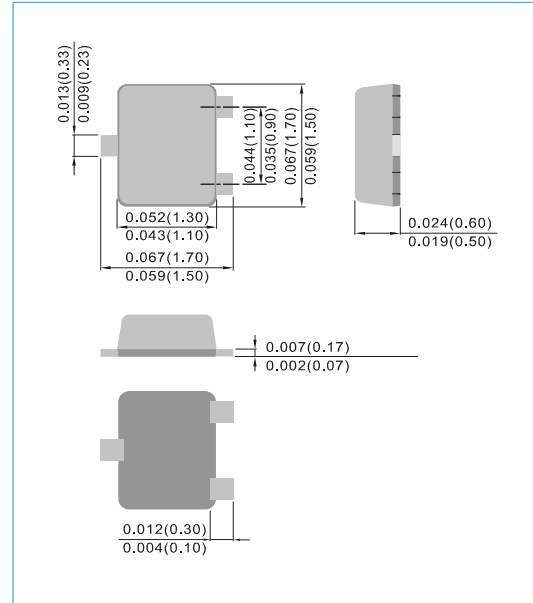

### MAXIMUM RATINGS AND ELECTRICAL CHARACTERISTICS (T<sub>A</sub>=25°C unless otherwise noted)

PARAMETER	SYMBOL	BAT54TB	BAT54ATB	BAT54CTB	BAT54RTB	BAT54STB	UNITS	
Marking code	-	LV	LW	LX	LG	LY	-	
Peak Repetitive Reverse Voltage	V <sub>RRM</sub>	30						V
Average Forward Current	I <sub>O</sub>	0.2						A
Peak Forward Surge Current, 1.0s (JEDEC method)	I <sub>FSM</sub>	0.6						A
Instantaneous Forward Voltage at I <sub>F</sub> =1mA at I <sub>F</sub> =100mA	V <sub>F</sub>	0.32 1.0						V
DC Reverse Current at Rated DC Blocking Voltage@V <sub>R</sub> =25V	I <sub>R</sub>	2.0						μA
Typical Junction Capacitance at V <sub>R</sub> =0V, f=1.0MHz	C <sub>J</sub>	10						pF
Typical Thermal Resistance, Junction to Ambient (Note 1)	R <sub>θJA</sub>	833						°C/ W
Operating Junction and Storage Temperature Range	T <sub>J</sub> , T <sub>STG</sub>	-55 to +125						°C
Circuit Figure	-	Single	Common Anode	Common Cathode	Series (Rev)	Series	-	

Note :

1. Mounted on minimum pad layout.

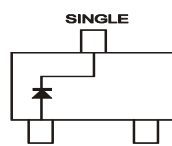

Fig.14(TOP VIEW)

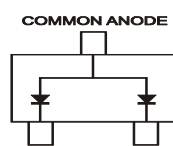

Fig.15(TOP VIEW)

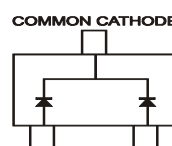

Fig.16(TOP VIEW)

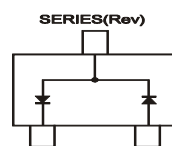

Fig.33(TOP VIEW)

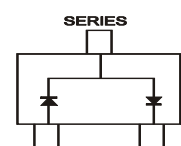

Fig.17(TOP VIEW)



# BAT54TB/ATB/CTB/RTB/STB

## RATING AND CHARACTERISTIC CURVES

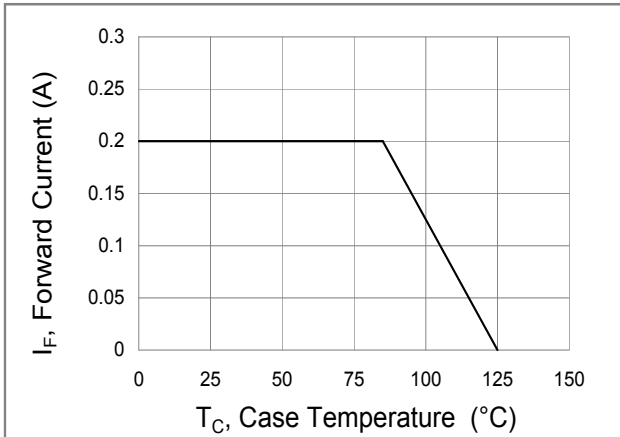

Fig.1 Forward Current Derating Curve

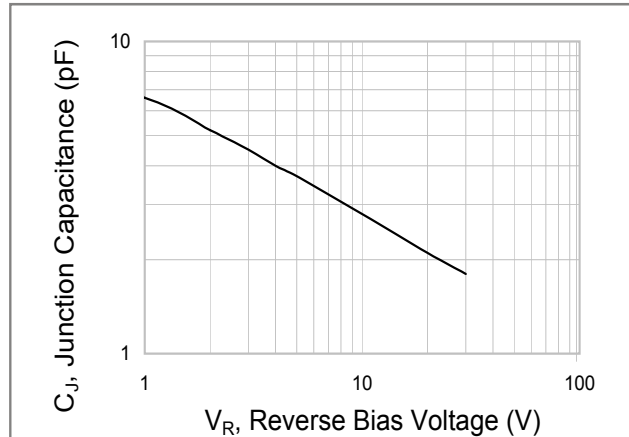

Fig.2 Typical Junction Capacitance

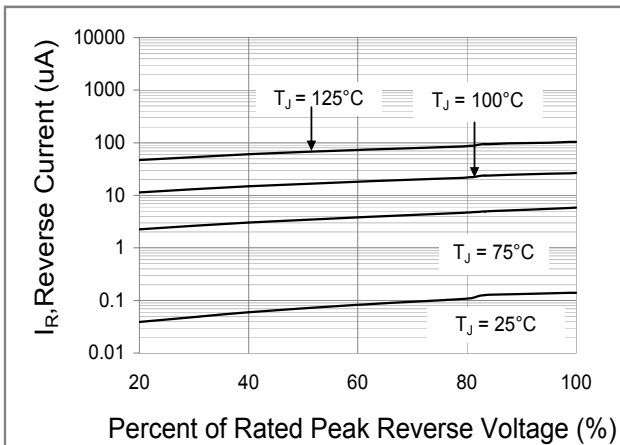

Fig.3 Typical Reverse Characteristics

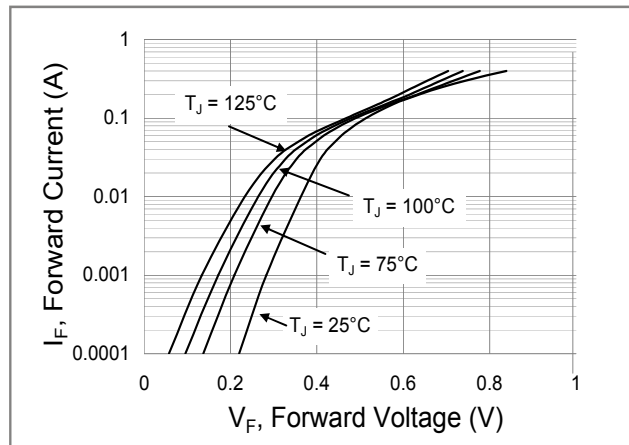
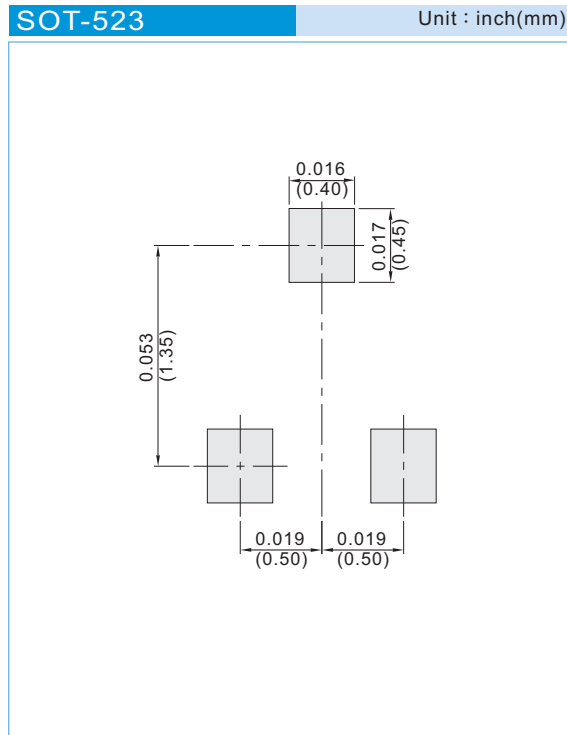

Fig.4 Typical Forward Characteristics



# BAT54TB/ATB/CTB/RTB/STB

## MOUNTING PAD LAYOUT



## ORDER INFORMATION

- Packing information

T/R - 4K per 7" plastic Reel



# BAT54TB/ATB/CTB/RTB/STB

Part No\_packing code\_Version

BAT54TB\_R1\_00001

For example :

**RB500V-40\_R2\_00001**

Part No.

Serial number

Version code means HF

Packing size code means 13"

Packing type means T/R

Packing Code <b>XX</b>				Version Code <b>XXXXX</b>		
Packing type	1 <sup>st</sup> Code	Packing size code	2 <sup>nd</sup> Code	HF or RoHS	1 <sup>st</sup> Code	2 <sup>nd</sup> ~5 <sup>th</sup> Code
Tape and Ammunition Box (T/B)	<b>A</b>	N/A	<b>0</b>	<b>HF</b>	<b>0</b>	serial number
Tape and Reel (T/R)	<b>R</b>	7"	<b>1</b>	<b>RoHS</b>	<b>1</b>	serial number
Bulk Packing (B/P)	<b>B</b>	13"	<b>2</b>			
Tube Packing (T/P)	<b>T</b>	26mm	<b>X</b>			
Tape and Reel (Right Oriented) (TRR)	<b>S</b>	52mm	<b>Y</b>			
Tape and Reel (Left Oriented) (TRL)	<b>L</b>	PANASERT T/B CATHODE UP (PBCU)	<b>U</b>			
FORMING	<b>F</b>	PANASERT T/B CATHODE DOWN (PBCD)	<b>D</b>			



## BAT54TB/ATB/CTB/RTB/STB

### Disclaimer

- Reproducing and modifying information of the document is prohibited without permission from Panjit International Inc..
- Panjit International Inc. reserves the rights to make changes of the content herein the document anytime without notification. Please refer to our website for the latest document.
- Panjit International Inc. disclaims any and all liability arising out of the application or use of any product including damages incidentally and consequentially occurred.
- Panjit International Inc. does not assume any and all implied warranties, including warranties of fitness for particular purpose, non-infringement and merchantability.
- Applications shown on the herein document are examples of standard use and operation. Customers are responsible in comprehending the suitable use in particular applications. Panjit International Inc. makes no representation or warranty that such applications will be suitable for the specified use without further testing or modification.
- The products shown herein are not designed and authorized for equipments requiring high level of reliability or relating to human life and for any applications concerning life-saving or life-sustaining, such as medical instruments, transportation equipment, aerospace machinery et cetera. Customers using or selling these products for use in such applications do so at their own risk and agree to fully indemnify Panjit International Inc. for any damages resulting from such improper use or sale.



## 2. MARKING

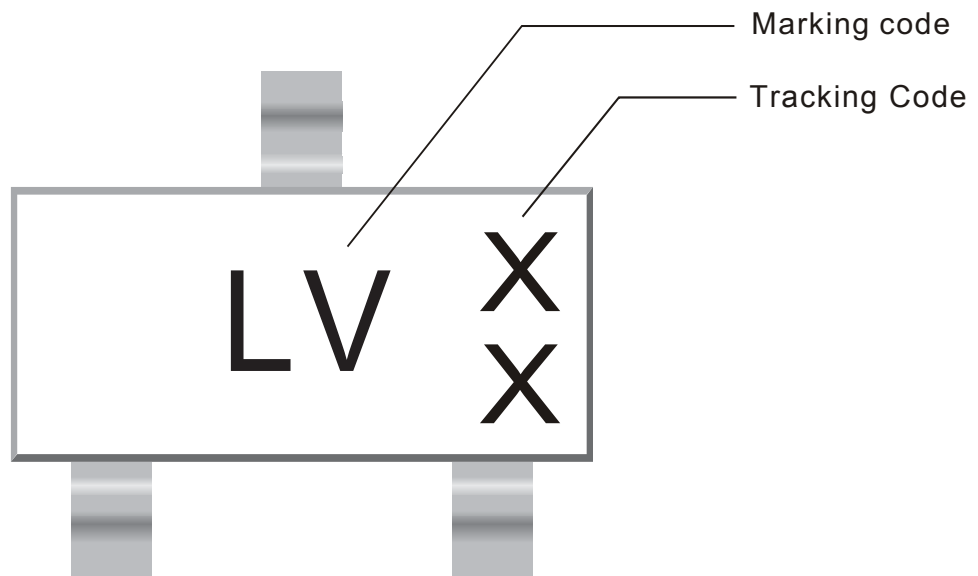



### 3. TAPING

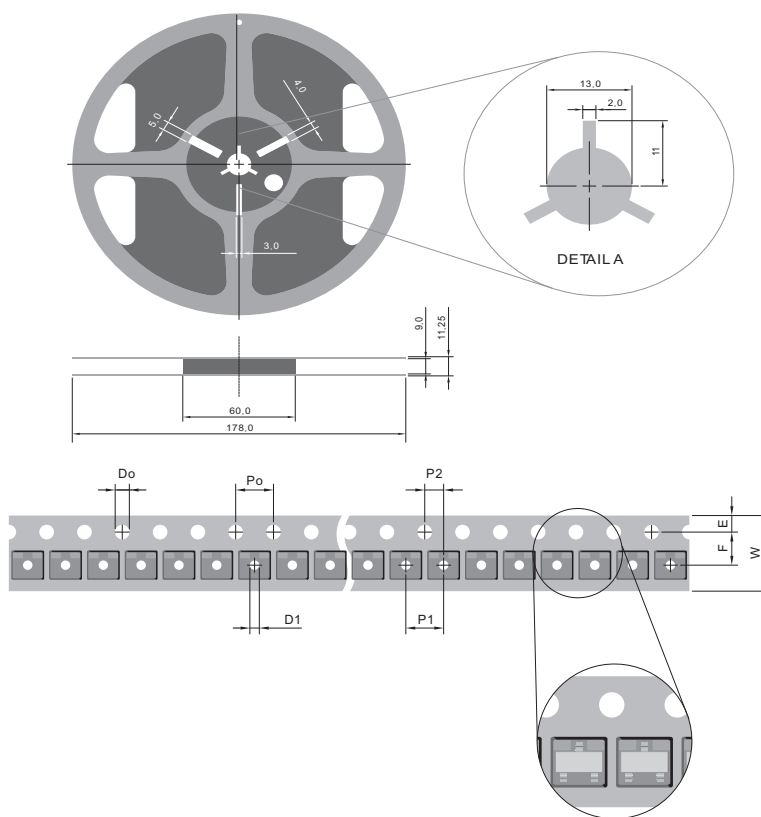

SYMBOL	mm (inch)
TYPE SIZE	8.00 (0.315)
D0	1.50 ± 0.10(0.059 ± 0.004)
D1	1.00 ± 0.25(0.02 ± 0.010)
E	1.75 ± 0.10(0.069 ± 0.004)
F	3.50 + 0.05(0.137 ± 0.002)
Po	4.00 ± 0.10(0.157 ± 0.004)
P1	4.00 ± 0.10(0.157 ± 0.004)
P2	2.00 ± 0.05(0.079 ± 0.002)
W	8.00 + 0.3 (0.315 + 0.012) - 0.15 - 0.006

NOTE:

1. There shall be leader of 230 mm minimum which may consist of carrier and or cover tape followed by a minimum of 160 mm of carrier tape sealed with cover tape.
2. There shall be minimum of 160 mm of empty component pockets sealed with cover tape.
3. Devices are packed in accordance with EIA standard EIA-481-A and specifications given above.





## 4. PACKING

### REEL PACKING



Quantity per Reel: 4,000 pcs

#### LABEL TYPE

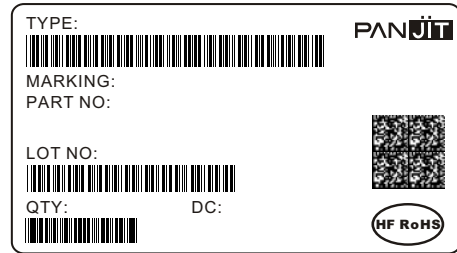

### CARTON

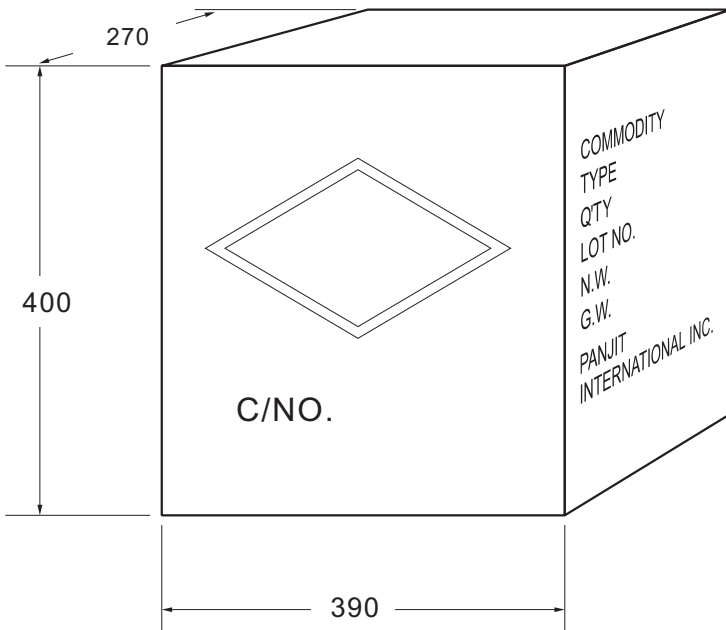

Box Dimensions : mm  
Quantity per Box: 320,000pcs

#### SHIPPING MARK

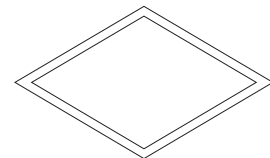

C/NO.  
PRODUCT COUNTRY

#### SIDE MARK

COMMODITY:  
TYPE:  
Q'TY:  
LOT NO.  
N.W.  
G.W.  
PANJIT  
INTERNATIONAL INC.



## Packing Specifications

Package	Reel Size	Reel	Component Space	Tape Space	Reel Dia	Carton Size	Carton	Approx. Gross Weight
	(inch)	(pcs)	(m/m)	(m/m)	(m/m)	(m/m)	(EA)	(Kg)
Reel Packing								
DFN 2L	7	8,000	2	8	178	390 x 270 x 400	640,000	8.6
DFN 3L	7	8,000	2	8	178	390 x 270 x 400	640,000	8.6
DFN 0603	7	10,000	2	8	178	390 x 270 x 400	800,000	9
DFN1616-8L	7	5,000	4	8	178	390 x 270 x 400	400,000	10.4
	13	12,000	4	8	330	375 x 360 x 213	144,000	7.6
SOD-123	7	3,000	4	8	178	390 x 270 x 400	240,000	9.9
	13	10,000	4	8	330	375 x 360 x 213	120,000	6.5
SOD-123FL	7	3,000	4	8	178	390 x 270 x 400	240,000	10.6
	13	10,000	4	8	330	375 x 360 x 213	120,000	7.2
SOD-123HE	7	3,000	4	8	178	390 x 270 x 400	240,000	12.4
	13	10,000	4	8	330	375 x 360 x 213	120,000	8.1
SOD-323	7	5,000	4	8	178	390 x 270 x 400	400,000	9.4
	13	12,000	4	8	330	375 x 360 x 213	144,000	5.9
SOD-323HE	7	5,000	4	8	178	390 x 270 x 400	400,000	11.9
	13	12,000	4	8	178	375 x 360 x 213	144,000	8.3
SOD-523	7	5,000	4	8	178	390 x 270 x 400	400,000	9.1
	13	12,000	4	8	330	375 x 360 x 213	144,000	5.4
SOD-723	7	8,000	2	8	178	390 x 270 x 400	640,000	8.5
SOD-923	7	8,000	2	8	178	390 x 270 x 400	640,000	7.7
SOT-23	7	3,000	4	8	178	390 x 270 x 400	240,000	9.8
	13	12,000	4	8	330	375 x 360 x 213	144,000	7
SOT-23 (ESD)	7	3,000	4	8	178	455 x 270 x 440	240,000	9.9
SOT-23 5L	7	3,000	4	8	178	390 x 270 x 400	240,000	14.5
	13	10,000	4	8	330	375 x 360 x 213	120,000	7.9
SOT-23 6L	7	3,000	4	8	178	390 x 270 x 400	240,000	14.5
	13	10,000	4	8	330	375 x 360 x 213	120,000	7.9
SOT-323	7	3,000	4	8	178	390 x 270 x 400	240,000	7.9
	13	12,000	4	8	330	375 x 360 x 213	144,000	6.1
SOT-323 (ESD)	7	3,000	4	8	178	455 x 270 x 440	240,000	9.4
SOT-353	7	3,000	4	8	178	390 x 270 x 400	240,000	10
	13	10,000	4	8	330	375 x 360 x 213	120,000	7.2
SOT-363	7	3,000	4	8	178	390 x 270 x 400	240,000	10.2
	13	10,000	4	8	330	375 x 360 x 213	120,000	7.1
SOT-363 (ESD)	7	3,000	4	8	178	455 x 270 x 440	240,000	10
SOT-523	7	4,000	4	8	178	390 x 270 x 400	320,000	10
SOT-543	7	4,000	4	8	178	390 x 270 x 400	320,000	9.4
	13	10,000	4	8	330	375 x 360 x 213	120,000	5.2
SOT-553	7	4,000	4	8	178	390 x 270 x 400	320,000	9.4
	13	10,000	4	8	330	375 x 360 x 213	120,000	5.2
SOT-563	7	4,000	4	8	178	390 x 270 x 400	320,000	9.4
	13	10,000	4	8	330	375 x 360 x 213	120,000	5.2



## Packing Specifications

Package	Reel Size	Reel	Component Space	Tape Space	Reel Dia	Carton Size	Carton	Approx. Gross Weight
	(inch)	(pcs)	(m/m)	(m/m)	(m/m)	(m/m)	(EA)	(Kg)
Reel Packing								
A-405	13	5,000	5	52	330	340 x 340 x 410	25,000	7.79
DO-15	13	4,000	5	52	330	340 x 340 x 410	20,000	11.4
DO-201AD	13	1,250	10	52	330	340 x 340 x 410	6,250	9.2
DO-201AE	13	1,250	10	52	330	340 x 340 x 410	6,250	9.2
DO-34	15	10,000	5	52	360	360 x 360 x 395	50,000	10.1
DO-35	15	10,000	5	52	360	360 x 360 x 395	50,000	11.2
DO-41	13	5,000	5	52	330	340 x 340 x 410	25,000	11.1
DO-41G	15	5,000	5	52	360	360 x 360 x 395	25,000	10.9
MDI	13	3,000	8	12	330	375 x 360 x 390	48,000	14.7
MELF/DL-41	7	1,500	4	-	178	385 x 380 x 260	84,000	18.3
	13	5,000	4	-	330	360 x 360 x 395	100,000	23.5
MICRO-MELF	7	2,500	4	-	178	385 x 380 x 260	200,000	9.3
	13	10,000	4	-	330	360 x 360 x 395	200,000	11.5
MINI-MELF/LL-34	7	2,500	4	-	178	385 x 380 x 260	200,000	12.7
	13	10,000	4	-	330	360 x 360 x 395	200,000	14.6
MICRO DIP/TDI	7	1,000	8	12	178	390 x 240 x 420	40,000	9.5
	13	4,000	8	12	330	375 x 360 x 390	64,000	17
P-600	13	800	10	52	330	340 x 340 x 410	4,000	9.9
QUADRO-MELF	13	10,000	4	-	330	360 x 360 x 395	200,000	14.9
	7	2,500	4	-	178	385 x 380 x 260	200,000	13.3
R-1	13	5,000	5	52	330	340 x 340 x 410	25,000	7.8
SDIP	13	1,500	12	16	330	375 x 360 x 390	21,000	14.3
SMA(W)	7	1,800	4	12	178	390 x 240 x 420	100,800	13
	13	7,500	4	12	330	355 x 355 x 400	150,000	20.4
SMA/DO-214AC	7	1,800	4	12	178	390 x 240 x 420	72,000	10
	13	7,500	4	12	330	375 x 360 x 390	120,000	17.4
SMAF	7	3,000	4	12	178	390 x 240 x 420	120,000	10.9
	13	10,000	4	12	330	375 x 360 x 390	160,000	17.1
SMBF	13	5,000	8	12	330	375 x 360 x 390	80,000	15.6
SMB/DO-214AA	7	500	8	12	178	390 x 240 x 420	20,000	6.5
	13	3,000	8	12	330	375 x 360 x 390	48,000	13.2
SMC/DO-214AB	7	500	8	16	178	390 x 240 x 420	15,000	8.4
	13	3,000	8	16	330	375 x 360 x 390	42,000	18
TO-252/DPAK	13	3,000	8	16	330	375 x 360 x 390	42,000	18.8
TO-263/D <sup>2</sup> PAK	13	800	16	24	330	375 x 360 x 390	6,400	14.5
TO-277	13	5,000	8	12	330	375 x 360 x 390	80,000	20.6



## Packing Specifications

Package	Inner Box Size	Box	Carton Size	Carton	Approx. Gross Weight
	(m/m)	(EA)	(m/m)	(EA)	(Kg)
<b>Bulk Packing</b>					
A-405	198 x 84 x 20	1,000	459 x 214 x 256	50,000	12.7
DO-15	200 x 85 x 25	1,000	459 x 214 x 256	40,000	20.7
DO-201AD	200 x 85 x 40	500	459 x 214 x 256	12,500	16
DO-201AE	200 x 85 x 40	500	495 x 214 x 256	12,500	16
DO-34	240 x 100 x 90	2,000	406 x 335 x 257	120,000	14.5
DO-35	240 x 100 x 90	2,000	406 x 335 x 257	120,000	17.1
DO-41	198 x 84 x 20	1,000	459 x 214 x 256	50,000	19.3
DO-41G	240 x 100 x 90	1,000	406 x 335 x 257	60,000	18.5
DIP	-	-	459 x 214 x 256	12,000	6.5
SDIP	-	-	459 x 214 x 256	24,000	15.7
R-1	198 x 84 x 20	1,000	459 x 214 x 256	50,000	12.7
P-600	208 x 90 x 83	500	459 x 214 x 256	5,000	11.3
ITO-220	540 x 145 x 85	2,000	555 x 306 x 200	8,000	20.5
TO-220	540 x 145 x 85	2,000	555 x 306 x 200	8,000	22.9
TO-251AB/DPAK	555 x 145 x 95	8,400	572 x 306 x 218	33,600	22
TO-3P/TO-247AD	-	-	530 x 243 x 100	1,500	13.9
TO-3PS/TO-247S	-	-	511 x 243 x 107	1,500	12.2

Package	Inner Box Size	Ammo	Component Space	Tape Space	Carton Size	Carton	Approx. Gross Weight
	(m/m)	(pcs)	(m/m)	(m/m)	(m/m)	(EA)	(Kg)
<b>Ammunition Packing</b>							
A-405	255 x 47 x 150	5,000	5	26	339 x 276 x 330	60,000	12.4
A-405	255 x 75 x 150	5,000	5	52	339 x 276 x 330	40,000	16
DO-15	255 x 75 x 150	3,000	5	52	339 x 276 x 330	24,000	13.3
DO-201AD	255 x 47 x 122	1,250	10	52	339 x 276 x 330	10,000	13.4
DO-201AE	255 x 47 x 122	1,250	10	52	339 x 276 x 330	10,000	13.4
DO-34	248 x 80 x 48	5,000	5	26	406 x 335 x 257	150,000	14.5
DO-34	248 x 80 x 75	5,000	5	52	406 x 335 x 257	100,000	12.7
DO-35	248 x 80 x 48	5,000	5	26	406 x 335 x 257	150,000	16.7
DO-35	248 x 80 x 75	5,000	5	52	406 x 335 x 257	100,000	15.2
DO-41	255 x 75 x 150	5,000	5	52	339 x 276 x 330	40,000	15.9
DO-41G	248 x 80 x 48	2,500	5	26	406 x 335 x 257	75,000	17.1
DO-41G	248 x 80 x 75	2,500	5	52	406 x 335 x 257	50,000	15.6
P-600	255 x 47 x 122	400	10	52	339 x 276 x 330	3,200	8.1
R-1	255 x 47 x 73	3,000	5	26	310 x 268 x 170	36,000	6.3
R-1	255 x 73 x 73	3,000	5	52	310 x 268 x 170	24,000	6.3
R-1	255 x 73 x 122	5,000	5	52	339 x 276 x 274	40,000	10.3

# 5.HIGH RELIABILITY TEST SPEC (Schottky & Switching & Rectifiers & Bridge)

Date : 2010.07.05 rev.01

NO.	TEST ITEM	TEST CONDITION	REFERENCED DOCUMENT	LOT QUALITY LEVEL
1	TEMPERATURE CYCLING (T.C.T) 溫度循環試驗	Ta = -55+0°C / -10°C 10min(Min) Ta = +150+15°C / -0°C 10min(Min) FOR 20CYCLES	MIL-STD-750D METHOD-1051.5 Condition G	LTPD 10 S.S=22 ACCEPT FOR 0 FAILURE ONLY.
2	HIGH TEMPERATURE STORAGE LIFE (H.T.S.L) 高溫儲存壽命試驗	Ta=Storage Temperature Range (device specified maximum temperature)	MIL-STD-750D METHOD-1032.2	LTPD 10 S.S=22 ACCEPT FOR 0 FAILURE ONLY.
3	SOLDERABILITY TEST 錫錫性試驗	Temperature of Solder TEMPERATURE OF SOLDER POT=245+/-5°C TIME FOR DIPPING IN SOLDER=5+/-0.5 SEC DIPPING DEPTH=0.05inch max from the body FOR ONE CYCLE	MIL-STD-750D METHOD-2026.10	LTPD 7 S.S=32 ACCEPT FOR 0 FAILURE ONLY.
4	HIGH TEMPERATURE REVERSE BIAS (H.T.R.B) 高溫逆向偏壓	Tj ≤ Tj max VR=0.8VR(CUSTOMER SPEC.) DC supply	MIL-STD-750D METHOD-1038.3	LTPD 10 S.S=22 ACCEPT FOR 0 FAILURE ONLY.
5	CONTINUE FORWARD OPERATING LIFE(C.F.O.L) 連續通電	Ta=25°C I = I <sub>o</sub> +/- 10% DC supply	MIL-STD-750D METHOD 1027.3	LTPD 10 S.S=22 ACCEPT FOR 0 FAILURE ONLY.
6	THERMAL SHOCK (T.S.T) 冷熱衝擊試驗	HOT TANK Ta=100+10/-2°C t= 5min COLD TANK Ta=0+2/-10°C t= 5min 15 CYCLES TIME BETWEEN TRANSFERRING DO NOT EXCEED 10 SEC	MIL-STD-750D METHOD 1056.7	LTPD 10 S.S=22 ACCEPT FOR 0 FAILURE ONLY.
7	PRESSURE COOKER (P.C.T) 壓力鍋試驗	Ta=121°C P=29.7psia / 205kPa or 2.088kg/cm <sup>2</sup> Relative Humidity = 100%	JEDEC JESD22-A102-C	LTPD 10 S.S=22 ACCEPT FOR 0 FAILURE ONLY.
8	INTERMITTENT FORWARD OPERATING LIFE (I.F.O.L) 斷續通電	I = I <sub>o</sub> x 1.0 DC supply POWER ON: at least 30 SEC POWER OFF: 50 SEC TESTING CYCLE: 2000CYCLES	MIL-STD-750D METHOD 1036.3	LTPD 10 S.S=22 ACCEPT FOR 0 FAILURE ONLY.
9	FORWARD SURGE CURRENT 順向突波電流測試	SQ WAVE OR SINE WAVE IFSM=DATE SHEET SPEC. TIME=Single half sine wave T= 1 CYCLE	MIL-STD-750D METHOD 4066-3	LTPD 10 S.S=22 ACCEPT FOR 0 FAILURE ONLY.
10	HUMIDITY 恆溫濕試驗	Ta=85+/-2°C RH=85+/-5%	EIAJ ED-4701 METHOD 103	LTPD 10 S.S=22 ACCEPT FOR 0 FAILURE ONLY.
11	SOLDER RESISTANCE 錫錫耐熱性試驗	TEMPERATURE OF SOLDER POT=260+/-5°C TIME FOR DIPPING IN SOLDER=10+2/-0 SEC DIPPING DEPTH=1.57+/-0.79mm FROM THE BODY FOR ONE CYCLE	MIL-STD-750D METHOD 2031.2	LTPD 10 S.S=22 ACCEPT FOR 0 FAILURE ONLY.