



TABLE OF CONTENTS

1.DATA SHEET

PAGE 1

2.MARKING

PAGE 6

3.TAPING

PAGE 7

4.PACKING

PAGE 8

5.HIGH RELIABILITY TEST SPEC.

PAGE 12



ES1AWG SERIES

SURFACE MOUNT SUPERFAST RECTIFIER

VOLTAGE 50 to 600 Volts **CURRENT** 1.0 Ampere

SMA(W)

Unit : inch(mm)

FEATURES

- For surface mounted applications
- Low profile package
- Built-in strain relief
- Easy pick and place
- Superfast recovery times for high efficiency
- Plastic package has Underwriters Laboratory Flammability Classification 94V-O
- Glass passivated junction
- Lead free in comply with EU RoHS 2011/65/EU directives
- Green molding compound as per IEC61249 Std. . (Halogen Free)

MECHANICAL DATA

- Case: JEDEC DO-214AC molded plastic
- Terminals: Solder plated, solderable per MIL-STD-750, Method 2026
- Polarity: Indicated by cathode band
- Standard packaging: 12mm tape (EIA-481)
- Weight: 0.0023 ounce, 0.0679 gram

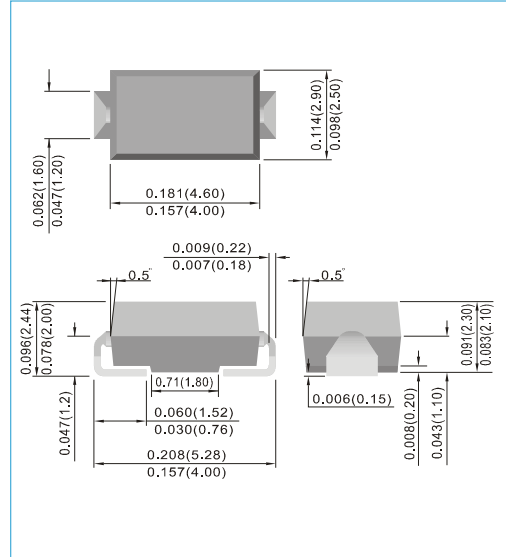

MAXIMUM RATINGS AND ELECTRICAL CHARACTERISTICS

Ratings at 25°C ambient temperature unless otherwise specified. Single phase, half wave, 60 Hz, resistive or inductive load. For capacitive load, derate current by 20%.

PARAMETER	SYMBOL	ES1AWG	ES1BWG	ES1CWG	ES1DWG	ES1EWG	ES1GWG	ES1JWG	UNITS
Maximum Recurrent Peak Reverse Voltage	V_{RRM}	50	100	150	200	300	400	600	V
Maximum RMS Voltage	V_{RMS}	35	70	105	140	210	280	420	V
Maximum DC Blocking Voltage	V_{DC}	50	100	150	200	300	400	600	V
Maximum Average Forward Current	$I_{F(AV)}$	1							A
Peak Forward Surge Current : 8.3ms single half sine-wave superimposed on rated load (JEDEC method)	I_{FSM}	30							A
Maximum Forward Voltage at 1A	V_F	0.95			1.25		1.7	V	
Maximum DC Reverse Current at Rated DC Blocking Voltage	I_R	1							μA
Typical Junction Capacitance	C_J	18							pF
Typical Thermal Resistance (Note 1) (Note 2)	$R_{\theta JA}$ $R_{\theta JL}$					150 22			$^{\circ}C / W$
Maximum Reverse Recovery Time (Note 3)	t_{rr}					35			ns
Operating Junction and Storage Temperature Range	T_J, T_{STG}	-55 to +150							$^{\circ}C$

NOTES:

1. Mounted on an FR4 PCB, single-sided copper, mini pad.
2. Mounted on an FR4 PCB, single-sided copper, with 76.2 x 114.3mm copper pad area.
3. Reverse Recovery Tset Conditions: $I_F=0.5A, I_R=1.0A, I_{rr}=0.25A$.



ES1AWG SERIES

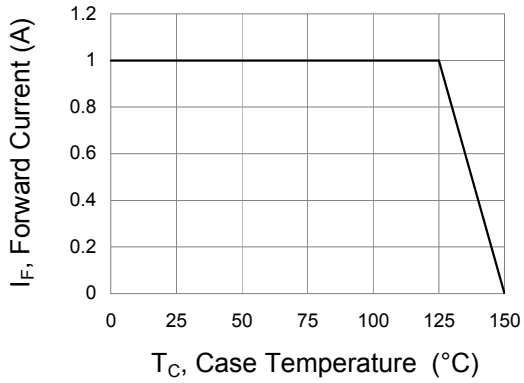

Fig.1 Forward Current Derating Curve

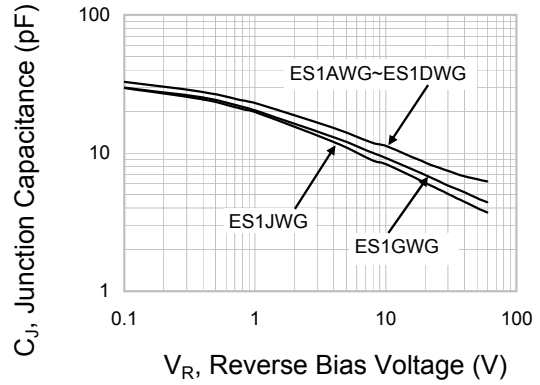

Fig.2 Typical Junction Capacitance

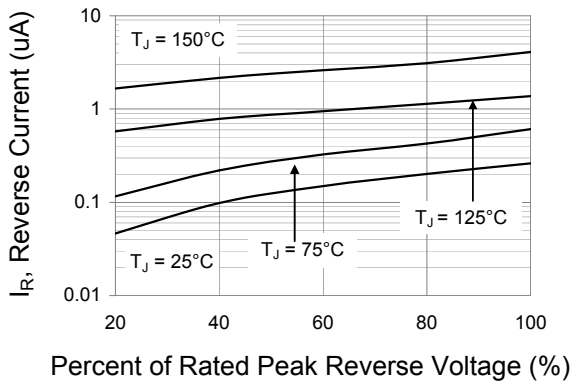

Fig.3 Typical Reverse Characteristics

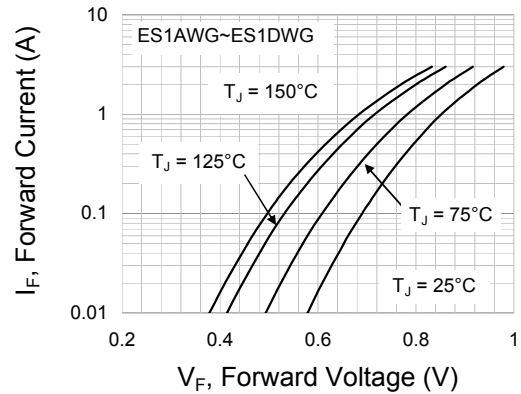

Fig.4 Typical Forward Characteristics

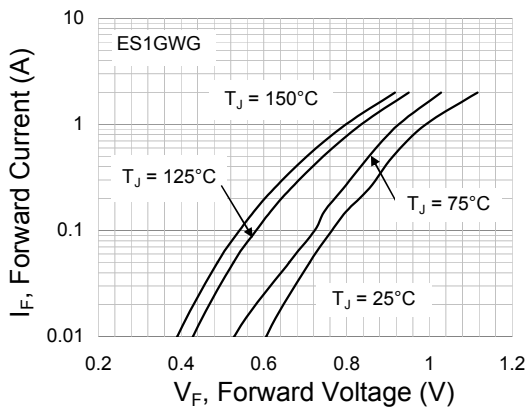

Fig.5 Typical Forward Characteristics

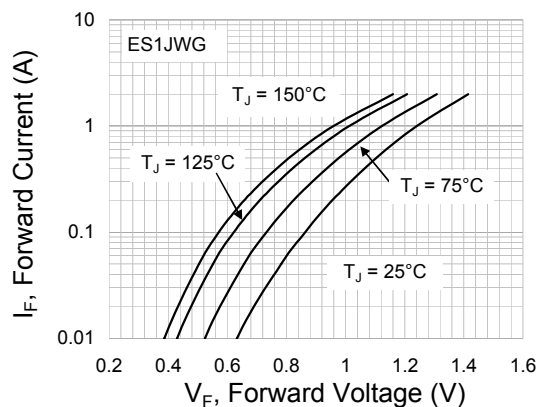
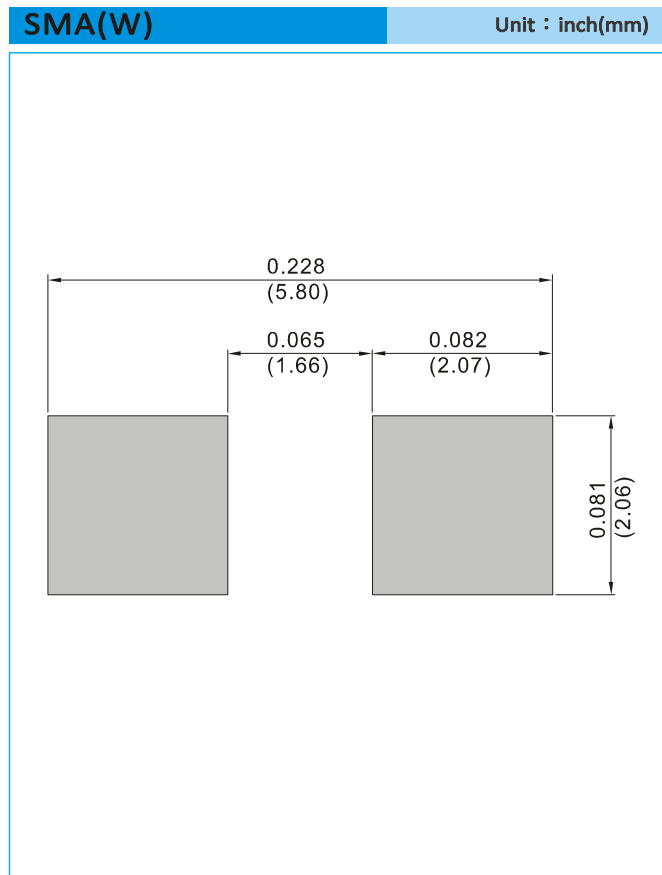

Fig.6 Typical Forward Characteristics



ES1AWG SERIES

MOUNTING PAD LAYOUT



ORDER INFORMATION

- Packing information
 - T/R - 7.5K per 13" plastic Reel
 - T/R - 1.8K per 7" plastic Reel



ES1AWG SERIES

Part No_packing code_Version

ES1AWG_R1_00001

ES1AWG_R2_00001

For example :

RB500V-40_R2_00001

Part No.

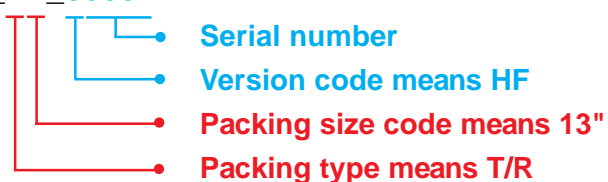

Packing Code XX				Version Code XXXXX		
Packing type	1 st Code	Packing size code	2 nd Code	HF or RoHS	1 st Code	2 nd ~5 th Code
Tape and Ammunition Box (T/B)	A	N/A	0	HF	0	serial number
Tape and Reel (T/R)	R	7"	1	RoHS	1	serial number
Bulk Packing (B/P)	B	13"	2			
Tube Packing (T/P)	T	26mm	X			
Tape and Reel (Right Oriented) (TRR)	S	52mm	Y			
Tape and Reel (Left Oriented) (TRL)	L	PANASERT T/B CATHODE UP (PBCU)	U			
FORMING	F	PANASERT T/B CATHODE DOWN (PBCD)	D			



ES1AWG SERIES

Disclaimer

- Reproducing and modifying information of the document is prohibited without permission from Panjit International Inc..
- Panjit International Inc. reserves the rights to make changes of the content herein the document anytime without notification. Please refer to our website for the latest document.
- Panjit International Inc. disclaims any and all liability arising out of the application or use of any product including damages incidentally and consequentially occurred.
- Panjit International Inc. does not assume any and all implied warranties, including warranties of fitness for particular purpose, non-infringement and merchantability.
- Applications shown on the herein document are examples of standard use and operation. Customers are responsible in comprehending the suitable use in particular applications. Panjit International Inc. makes no representation or warranty that such applications will be suitable for the specified use without further testing or modification.
- The products shown herein are not designed and authorized for equipments requiring high level of reliability or relating to human life and for any applications concerning life-saving or life-sustaining, such as medical instruments, transportation equipment, aerospace machinery et cetera. Customers using or selling these products for use in such applications do so at their own risk and agree to fully indemnify Panjit International Inc. for any damages resulting from such improper use or sale.
- Since Panjit uses lot number as the tracking base, please provide the lot number for tracking when complaining.



2. MARKING

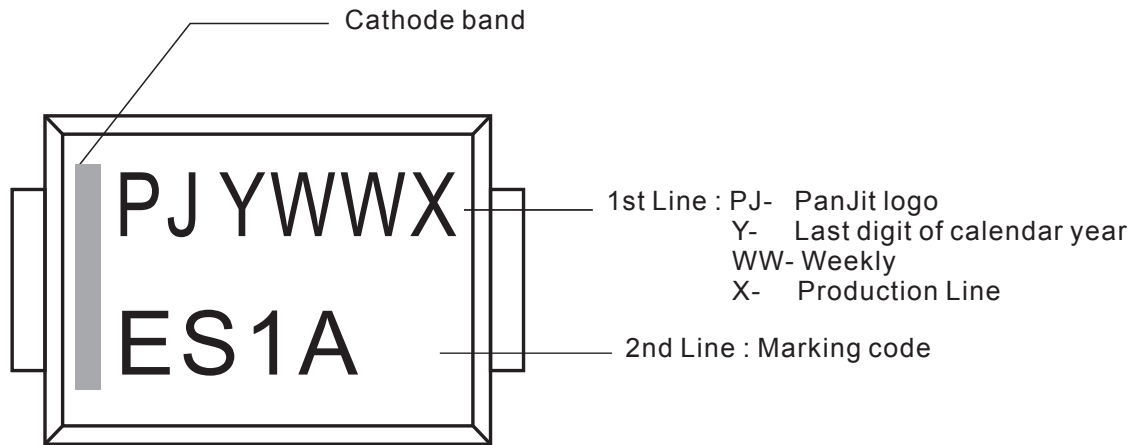



3. TAPING

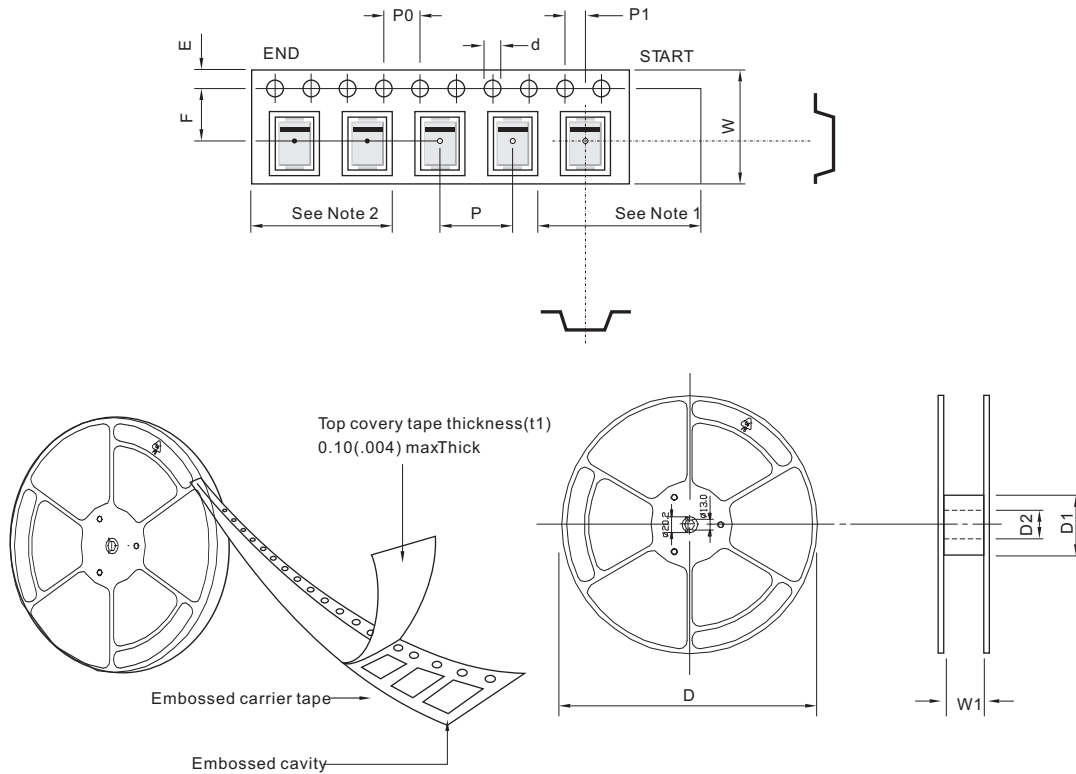

SYMBOL	mm(inch)	SYMBOL	mm(inch)	SYMBOL	mm(inch)
TYPE SIZE	12.00 (0.472)	TYPE SIZE	12.00 (0.472)	TYPE SIZE	16.00 (0.629)
Package	SMA/SMA(W)	Package	SMB	Package	SMC
d	1.55 + 0.05 (0.06 + 0.001)	d	1.55 + 0.05 (0.06 + 0.001)	d	1.55 ± 0.05 (0.06 ± 0.001)
D	178.0 + 2.0 (7.0 + 0.078)	D	178.0 + 2.0 (13.0 + 0.078)	D	178.0 ± 2.0 (13.0 ± 0.078)
D1	50.0 min (1.97 min)	D1	50.0 min (1.97 min)	D1	50.0 min (1.97 min)
D2	13.0 ± 0.2 (0.51 ± 0.007)	D2	13.0 ± 0.2 (0.51 ± 0.007)	D2	13.0 ± 0.5 (0.51 ± 0.019)
E	1.75 + 0.10 (0.068 + 0.003)	E	1.75 + 0.10 (0.068 + 0.003)	E	1.75 ± 0.10 (0.068 ± 0.003)
F	5.50 + 0.1 (0.21 + 0.003)	F	5.50 + 0.05 (0.21 + 0.001)	F	7.5 ± 0.10 (0.29 ± 0.003)
P	4.00 + 0.10 (0.15 + 0.003)	P	8.00 + 0.10 (0.31 + 0.003)	P	8.00 ± 0.10 (0.31 ± 0.003)
Po	4.00 + 0.10 (0.15 + 0.003)	Po	4.00 + 0.10 (0.15 + 0.003)	Po	4.00 ± 0.10 (0.15 ± 0.003)
P1	2.00 + 0.1 (0.07 + 0.003)	P1	2.00 + 0.05 (0.07 + 0.001)	P1	2.00 ± 0.10 (0.07 ± 0.003)
W	12.00 + 0.3 (0.472 + 0.118)	W	12.00 + 0.3 (0.472 + 0.118)	W	16.00 ± 0.3 (0.472 ± 0.118)
W1	12.40 ~ 14.40Maxmum (0.48 ~ 0.56)	W1	12.40 ~ 14.40Maxmum (0.48 ~ 0.56)	W1	16.40 ~ 18.40Maxmum (0.64 ~ 0.72)

Note:

1. There shall be leader of 230 mm minimum which may consist of carrier and or cover tape follower by a minimum of 160 mm of carrier tape sealed with cover tape.
2. There shall be minimum of 160 mm of empty component pockets sealed with cover tape.
3. Devices are packed in accordance whit EIA standard EIA-481-A and specifications given above.

4. PACKING

REEL PACKING

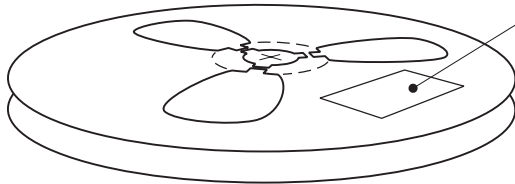

Quantity per Reel:

LABEL TYPE

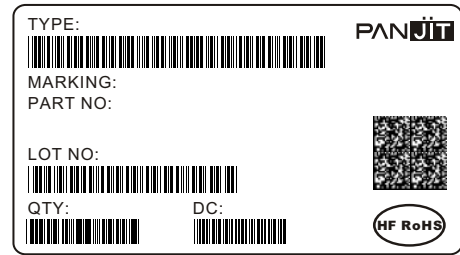

CARTON

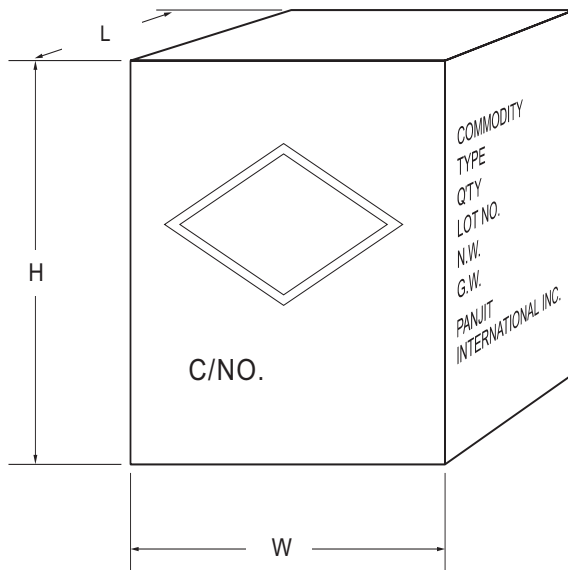

Box Dimensions : mm
Quantity per Box:

SHIPPING MARK

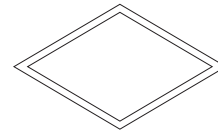

C/NO.
PRODUCT COUNTRY

SIDE MARK

COMMODITY:
TYPE:
Q'TY:
LOT NO.
N.W.
G.W.
PANJIT
INTERNATIONAL INC.

Line	Package	Packing	Size	Quantity	Inner box size LxWxH (m/m)	Carton Quantity	Carton size LxWxH (m/m)
SMD	SMA	T/R	7"	1,800	188x188x67	10box/72K	390x240x420
	SMB	T/R		500	188x188x67	10box/20K	390x240x420
	SMC	T/R		500	188x188x67	10box/15K	390x240x420
	SMA(W)	T/R	13"	1,800	188x188x67	10box/72K	390x240x420
	SMA	T/R		7,500	350x337x44	8box/120K	375x360x390
	SMB	T/R		3,000	350x337x44	8box/48K	375x360x390
	SMC	T/R		3,000	350x337x44	7box/42K	375x360x390
	SMA(W)	T/R		7,500	350x337x44	8box/120K	355x355x400



Packing Specifications

Package	Reel Size	Reel	Component Space	Tape Space	Reel Dia	Carton Size	Carton	Approx. Gross Weight
	(inch)	(pcs)	(m/m)	(m/m)	(m/m)	(m/m)	(EA)	(Kg)
Reel Packing								
DFN 0603	7	10,000	2	8	178	390 x 270 x 400	800,000	9
DFN 2L	7	8,000	2	8	178	390 x 270 x 400	640,000	8.6
DFN 3L	7	8,000	2	8	178	390 x 270 x 400	640,000	8.6
DFN1616-8L	7	5,000	4	8	178	390 x 270 x 400	400,000	10.4
	13	12,000	4	8	330	375 x 360 x 230	144,000	7.6
SOD-923	7	8,000	2	8	178	390 x 270 x 400	640,000	7.7
SOD-523	7	5,000	4	8	178	390 x 270 x 400	400,000	9.1
	13	12,000	4	8	330	375 x 360 x 230	144,000	5.4
SOD-323HE	7	5,000	4	8	178	390 x 270 x 400	400,000	11.9
	13	12,000	4	8	178	375 x 360 x 230	144,000	8.3
SOD-323	7	5,000	4	8	178	390 x 270 x 400	400,000	9.4
	13	12,000	4	8	330	375 x 360 x 230	144,000	5.9
SOD-123HE	7	3,000	4	8	178	390 x 270 x 400	240,000	12.4
	13	10,000	4	8	330	375 x 360 x 230	120,000	8.1
SOD-123FL	7	3,000	4	8	178	390 x 270 x 400	240,000	10.6
	13	10,000	4	8	330	375 x 360 x 230	120,000	7.2
SOD-123	7	3,000	4	8	178	390 x 270 x 400	240,000	9.9
	13	10,000	4	8	330	375 x 360 x 230	120,000	6.5
SOT-563	7	4,000	4	8	178	390 x 270 x 400	320,000	9.4
	13	10,000	4	8	330	375 x 360 x 230	120,000	5.2
SOT-553	7	4,000	4	8	178	390 x 270 x 400	320,000	9.4
	13	10,000	4	8	330	375 x 360 x 230	120,000	5.2
SOT-543	7	4,000	4	8	178	390 x 270 x 400	320,000	9.4
	13	10,000	4	8	330	375 x 360 x 230	120,000	5.2
SOT-523	7	4,000	4	8	178	390 x 270 x 400	320,000	10
SOT-363	7	3,000	4	8	178	390 x 270 x 400	240,000	10.2
	13	10,000	4	8	330	375 x 360 x 230	120,000	7.1
SOT-363 (ESD)	7	3,000	4	8	178	455 x 270 x 440	240,000	10
SOT-353	7	3,000	4	8	178	390 x 270 x 400	240,000	10
	13	10,000	4	8	330	375 x 360 x 230	120,000	7.2
SOT-23 6L	7	3,000	4	8	178	390 x 270 x 400	240,000	14.5
	13	10,000	4	8	330	375 x 360 x 230	120,000	7.9
SOT-23 6L-1	7	3,000	4	8	178	390 x 270 x 400	240,000	14.5
	13	10,000	4	8	330	375 x 360 x 230	120,000	7.9
SOT-23 5L	7	3,000	4	8	178	390 x 270 x 400	240,000	14.5
	13	10,000	4	8	330	375 x 360 x 230	120,000	7.9
SOT-323	7	3,000	4	8	178	390 x 270 x 400	240,000	7.9
	13	12,000	4	8	330	375 x 360 x 230	144,000	6.1
SOT-323 (ESD)	7	3,000	4	8	178	455 x 270 x 440	240,000	9.4
SOT-23-1	7	3,000	4	8	178	390 x 270 x 400	240,000	9.8
	13	12,000	4	8	330	375 x 360 x 230	144,000	7
SOT-23	7	3,000	4	8	178	390 x 270 x 400	240,000	9.8
	13	12,000	4	8	330	375 x 360 x 230	144,000	7
SOT-23 (ESD)	7	3,000	4	8	178	455 x 270 x 440	240,000	9.9



Packing Specifications

Package	Reel Size	Reel	Component Space	Tape Space	Reel Dia	Carton Size	Carton	Approx. Gross Weight
	(inch)	(pcs)	(m/m)	(m/m)	(m/m)	(m/m)	(EA)	(Kg)
Reel Packing								
SMAF	7	3,000	4	12	178	390 x 240 x 420	120,000	10.9
	13	10,000	4	12	330	375 x 360 x 422	160,000	17.1
SMBF	13	5,000	8	12	330	375 x 360 x 422	80,000	15.6
SMA(W)	7	1,800	4	12	178	390 x 240 x 420	100,800	13
	13	7,500	4	12	330	355 x 355 x 400	150,000	20.4
SMA/DO-214AC	7	1,800	4	12	178	390 x 240 x 420	72,000	10
	13	7,500	4	12	330	375 x 360 x 390	120,000	17.4
SMB/DO-214AA	7	500	8	12	178	390 x 240 x 420	20,000	6.5
	13	3,000	8	12	330	375 x 360 x 390	48,000	13.2
SMC/DO-214AB	7	500	8	16	178	390 x 240 x 420	15,000	8.4
	13	3,000	8	16	330	375 x 360 x 390	42,000	18
R-1	13	5,000	5	52	330	340 x 340 x 410	25,000	7.8
A-405	13	5,000	5	52	330	340 x 340 x 410	25,000	7.79
DO-41	13	5,000	5	52	330	340 x 340 x 410	25,000	11.1
DO-15	13	4,000	5	52	330	340 x 340 x 410	20,000	11.4
DO-201AD	13	1,250	10	52	330	340 x 340 x 410	6,250	9.2
DO-201AE	13	1,250	10	52	330	340 x 340 x 410	6,250	9.2
P-600	13	800	10	52	330	340 x 340 x 410	4,000	9.9
DO-34	15	10,000	5	52	360	360 x 360 x 395	50,000	10.1
DO-35	15	10,000	5	52	360	360 x 360 x 395	50,000	11.2
DO-41G	15	5,000	5	52	360	360 x 360 x 395	25,000	10.9
MICRO-MELF	7	2,500	4	-	178	385 x 380 x 260	200,000	9.3
	13	10,000	4	-	330	360 x 360 x 395	200,000	11.5
QUADRO-MELF	13	10,000	4	-	330	360 x 360 x 395	200,000	14.9
	7	2,500	4	-	178	385 x 380 x 260	200,000	13.3
MINI-MELF/LL-34	7	2,500	4	-	178	385 x 380 x 260	200,000	12.7
	13	10,000	4	-	330	360 x 360 x 395	200,000	14.6
MELF/DL-41	7	1,500	4	-	178	385 x 380 x 260	84,000	18.3
	13	5,000	4	-	330	360 x 360 x 395	100,000	23.5
MDI	13	3,000	8	12	330	375 x 360 x 390	48,000	14.7
MICRO DIP/TDI	7	1,000	8	12	178	390 x 240 x 420	40,000	9.5
	13	4,000	8	12	330	375 x 360 x 422	64,000	17
SDIP	13	1,500	12	16	330	375 x 360 x 390	21,000	14.3
TO-277	13	5,000	8	12	330	375 x 360 x 422	80,000	20.6
TO-277B	13	5,000	8	12	330	375 x 360 x 390	80,000	21.8
TO-252/DPAK	13	3,000	8	16	330	375 x 360 x 422	42,000	18.8
TO-263/D ² PAK	13	800	16	24	330	375 x 360 x 422	6,400	14.5



Packing Specifications

Package	Inner Box Size	Box	Carton Size	Carton	Approx. Gross Weight
	(m/m)	(EA)	(m/m)	(EA)	(Kg)
Bulk Packing					
R-1	198 x 84 x 20	1,000	459 x 214 x 256	50,000	12.7
A-405	198 x 84 x 20	1,000	459 x 214 x 256	50,000	12.7
DO-41	198 x 84 x 20	1,000	459 x 214 x 256	50,000	19.3
DO-15	200 x 85 x 25	1,000	459 x 214 x 256	40,000	20.7
DO-201AD	200 x 85 x 40	500	459 x 214 x 256	12,500	16
DO-201AE	200 x 85 x 40	500	495 x 214 x 256	12,500	16
P-600	208 x 90 x 83	500	459 x 214 x 256	5,000	11.3
DO-34	240 x 100 x 90	2,000	406 x 335 x 257	120,000	14.5
DO-35	240 x 100 x 90	2,000	406 x 335 x 257	120,000	17.1
DO-41G	240 x 100 x 90	1,000	406 x 335 x 257	60,000	18.5
TO-220	540 x 145 x 85	2,000	555 x 306 x 200	8,000	22.9
ITO-220	540 x 145 x 85	2,000	555 x 306 x 200	8,000	20.5
TO-251AB/DPAK	555 x 145 x 95	8,400	572 x 306 x 218	33,600	22
TO-3PN	-	-	600x185x230	1,800	16.4
TO-247AD/TO-3P	-	-	530 x 243 x 100	1,500	13.9
TO-247S/TO-3PS	-	-	511 x 243 x 107	1,500	12.2
DIP	-	-	459 x 214 x 256	12,000	6.5
SDIP	-	-	459 x 214 x 256	24,000	15.7

Package	Inner Box Size	Ammo	Component Space	Tape Space	Carton Size	Carton	Approx. Gross Weight
	(m/m)	(pcs)	(m/m)	(m/m)	(m/m)	(EA)	(Kg)
Ammunition Packing							
R-1	255 x 47 x 73	3,000	5	26	310 x 268 x 170	36,000	6.3
	255 x 73 x 73	3,000	5	52	310 x 268 x 170	24,000	6.3
	255 x 73 x 122	5,000	5	52	339 x 276 x 274	40,000	10.3
A-405	255 x 47 x 150	5,000	5	26	339 x 276 x 330	60,000	12.4
	255 x 75 x 150	5,000	5	52	339 x 276 x 330	40,000	16
DO-41	255 x 75 x 150	5,000	5	52	339 x 276 x 330	40,000	15.9
DO-15	255 x 75 x 150	3,000	5	52	339 x 276 x 330	24,000	13.3
DO-201AD	255 x 47 x 122	1,250	10	52	339 x 276 x 330	10,000	13.4
DO-201AE	255 x 47 x 122	1,250	10	52	339 x 276 x 330	10,000	13.4
P-600	255 x 47 x 122	400	10	52	339 x 276 x 330	3,200	8.1
DO-34	248 x 80 x 48	5,000	5	26	406 x 335 x 257	150,000	14.5
	248 x 80 x 75	5,000	5	52	406 x 335 x 257	100,000	12.7
DO-35	248 x 80 x 48	5,000	5	26	406 x 335 x 257	150,000	16.7
	248 x 80 x 75	5,000	5	52	406 x 335 x 257	100,000	15.2
DO-41G	248 x 80 x 48	2,500	5	26	406 x 335 x 257	75,000	17.1
	248 x 80 x 75	2,500	5	52	406 x 335 x 257	50,000	15.6

5.HIGH RELIABILITY TEST SPEC (Schottky & Switching & Rectifiers & Bridge)

Date : 2013.02.22 rev.02

NO.	TEST ITEM	TEST CONDITION	REFERENCED DOCUMENT	LOT QUALITY LEVEL
1	TEMPERATURE CYCLING (T.C.T) 溫度循環試驗	Ta = -55 + 0°C / -10°C 10min(Min) Ta = +150 + 15°C / -0°C 10min(Min) FOR 20CYCLES	MIL-STD-750D METHOD-1051.5 Condition G	LTPD 10 S.S=22 ACCEPT FOR 0 FAILURE ONLY.
2	HIGH TEMPERATURE STORAGE LIFE (H.T.S.L) 高溫儲存壽命試驗	Ta = Storage Temperature Range (device specified maximum temperature)	MIL-STD-750D METHOD-1032.2	LTPD 10 S.S=22 ACCEPT FOR 0 FAILURE ONLY.
3	SOLDERABILITY TEST 錫錫性試驗	Temperature of Solder TEMPERATURE OF SOLDER POT = 245 + / - 5°C TIME FOR DIPPING IN SOLDER = 5 + / - 0.5 SEC DIPPING DEPTH = 0.05inch max from the body FOR ONE CYCLE	MIL-STD-750D METHOD-2026.10	LTPD 7 S.S=32 ACCEPT FOR 0 FAILURE ONLY.
4	HIGH TEMPERATURE REVERSE BIAS (H.T.R.B) 高溫逆向偏壓	Tj ≤ Tj max VR = 0.8VR (CUSTOMER SPEC.) DC supply	MIL-STD-750D METHOD-1038.3	LTPD 10 S.S=22 ACCEPT FOR 0 FAILURE ONLY.
5	CONTINUE FORWARD OPERATING LIFE (C.F.O.L) 連續通電	Ta = 25°C I = Io + / - 10% DC supply	MIL-STD-750D METHOD 1027.3	LTPD 10 S.S=22 ACCEPT FOR 0 FAILURE ONLY.
6	THERMAL SHOCK (T.S.T) 冷熱衝擊試驗	HOT TANK Ta = 100 + 10 / - 2°C t = 5min COLD TANK Ta = 0 + 2 / - 10°C t = 5min 15 CYCLES TIME BETWEEN TRANSFERRING DO NOT EXCEED 10 SEC	MIL-STD-750D METHOD 1056.7	LTPD 10 S.S=22 ACCEPT FOR 0 FAILURE ONLY.
7	PRESSURE COOKER (P.C.T) 壓力鍋試驗	Ta = 121°C P = 29.7psia / 205kPa or 2.088kg/cm ² Relative Humidity = 100%	JEDEC JESD22-A102-C	LTPD 10 S.S=22 ACCEPT FOR 0 FAILURE ONLY.
8	INTERMITTENT FORWARD OPERATING LIFE (I.F.O.L) 斷續通電	I = Io × 1.0 DC supply POWER ON: at least 30 SEC POWER OFF: 50 SEC TESTING CYCLE: 2000CYCLES	MIL-STD-750D METHOD 1036.3	LTPD 10 S.S=22 ACCEPT FOR 0 FAILURE ONLY.
9	FORWARD SURGE CURRENT 順向突波電流測試	SQ WAVE OR SINE WAVE IFSM = DATE SHEET SPEC. TIME = DATE SHEET SPEC. T = 1 CYCLE	MIL-STD-750D METHOD 4066-3	LTPD 10 S.S=22 ACCEPT FOR 0 FAILURE ONLY.
10	HUMIDITY 恆溫濕試驗	Ta = 85 + / - 2°C RH = 85 + / - 5%	EIAJ ED-4701 METHOD 103	LTPD 10 S.S=22 ACCEPT FOR 0 FAILURE ONLY.
11	SOLDER RESISTANCE 錫錫耐熱性試驗	TEMPERATURE OF SOLDER POT = 260 + / - 5°C TIME FOR DIPPING IN SOLDER = 10 + 2 / - 0 SEC DIPPING DEPTH = 1.57 + / - 0.79mm FROM THE BODY FOR ONE CYCLE	MIL-STD-750D METHOD 2031.2	LTPD 10 S.S=22 ACCEPT FOR 0 FAILURE ONLY.