



MMBT5401-AU

HIGH VOLTAGE TRANSISTOR PNP Silicon

FEATURES

- Lead free in compliance with EU RoHS 2.0
- Green molding compound as per IEC 61249 standard
- AEC-Q101 qualified

MECHANICAL DATA

- Case : SOT-23 plastic case.
- Terminals : Solderable per MIL-STD-750, Method 2026
- Standard packaging : 8mm tape
- Approx. Weight : 0.0003 ounces, 0.008 grams
- Marking : M5A

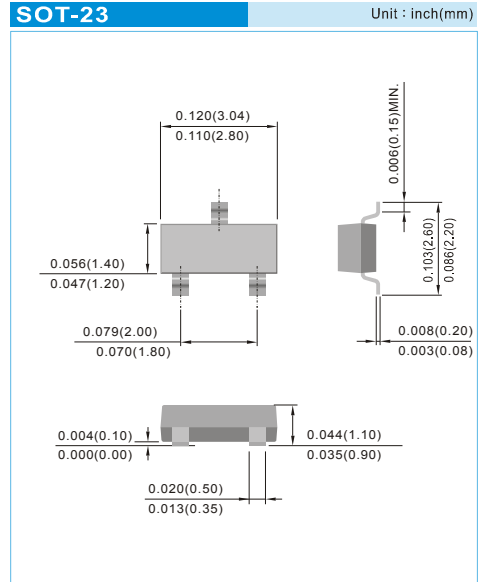

MAXIMUM RATINGS

RATING	SYMBOL	VALUE	UNITS
Collector-Emitter Voltage	V _{CEO}	-150	Vdc
Collector-Base Voltage	V _{CBO}	-160	Vdc
Emitter-Base Voltage	V _{EBO}	-5.0	Vdc
Collector Current-Continuous	I _C	-600	mAdc

Maximum ratings are those values beyond which device damage can occur. Maximum ratings applied to the device are individual stress limit values (not normal operating conditions) and are not valid simultaneously. If these limits are exceeded, device functional operational is not implied, damage may occur and reliability may be affected.

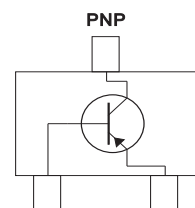

Fig.35



MMBT5401-AU

THERMAL CHARACTERISTICS

CHARACTERISTIC	SYMBOL	MAX	UNITS
Total Device Dissipation FR-4 Board (Note 1) T _A =25°C Derate Above 25°C	P _D	225	mW
		1.8	mW/°C
Thermal Resistance, Junction-to-Ambient	R _{θJA}	556	°C/W
Total Device Dissipation Alumina Substrate (Note 2) T _A =25°C Derate Above 25°C	P _D	300	mW
		2.4	mW/°C
Thermal Resistance Junction-to-Ambient	R _{θJA}	417	°C/W
Junction and Storage Temperature	T _J , T _{STG}	-55 to +150	°C

1.FR-4 = 70 X 60 X 1mm

2.Alumina = 0.4 X 0.3 X 0.024 in 99.5% alumina

ELECTRICAL CHARACTERISTICS (T_A=25°C unless otherwise noted)

CHARACTERISTIC	SYMBOL	MIN	MAX	UNITS
OFF CHARACTERISTICS				
Collector-Emitter Breakdown Voltage (I _C =-1.0mA _{dc} , I _B =0)	V _{(BR)CEO}	-150	-	V _{dc}
Collector-Base Breakdown Voltage (I _C =-100μA _{dc} , I _E =0)	V _{(BR)CBO}	-160	-	V _{dc}
Emitter-Base Breakdown Voltage (I _E =-10μA _{dc} , I _C =0)	V _{(BR)EBO}	-5.0	-	V _{dc}
Collector Cutoff Current (V _{CB} =-120V _{dc} , I _E =0) (V _{CB} =-120V _{dc} , I _E =0, T _A =100°C)	I _{CBO}	-	-50 -50	nA _{dc} μA _{dc}
ON CHARACTERISTICS				
DC Current Gain (I _C =-1.0mA _{dc} , V _{CE} =-5.0V _{dc}) (I _C =-10mA _{dc} , V _{CE} =-5.0V _{dc}) (I _C =-50mA _{dc} , V _{CE} =-5.0V _{dc})	h _{FE}	50 60 50	- 240 -	-
Collector-Emitter Saturation Voltage (I _C =-10mA _{dc} , I _B =-1.0mA _{dc}) (I _C =-50mA _{dc} , I _B =-5.0mA _{dc})	V _{CE(SAT)}	- -	-0.2 -0.5	V _{dc}
Base-Emitter Saturation Voltage (I _C =-10mA _{dc} , I _B =-1.0mA _{dc}) (I _C =-50mA _{dc} , I _B =-5.0mA _{dc})	V _{BE(SAT)}	- -	-1.0 -1.0	V _{dc}
SMALL-SIGNAL CHARACTERISTICS				
Current-Gain-Bandwidth Product (I _C =-10mA _{dc} , V _{CE} =-10V _{dc} , f=100MHz)	f _r	100	300	MHz
Output Capacitance (V _{CB} =-10V _{dc} , I _E =0, f=1.0MHz)	C _{OB0}	-	6.0	pF
Small Signal Current Gain (I _C =-1.0mA _{dc} , V _{CE} =-10V _{dc} , f=1.0kHz)	h _{FE}	40	200	-
Noise Figure (I _C =-200μA _{dc} , V _{CE} =-5.0V _{dc} , R _s =10Ω, f=1.0kHz)	NF	-	8.0	dB



MMBT5401-AU

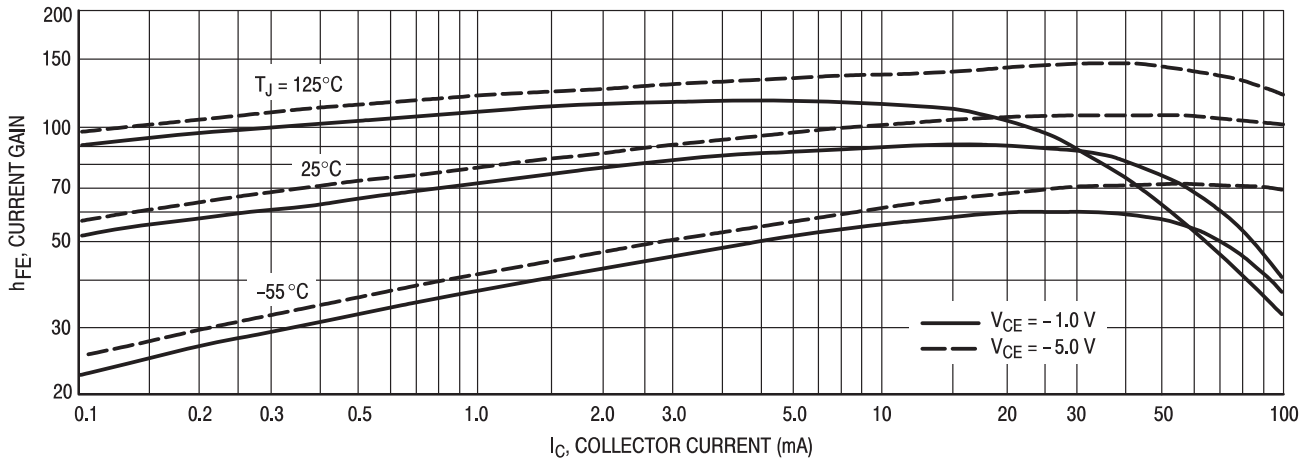

Figure 1. DC Current Gain

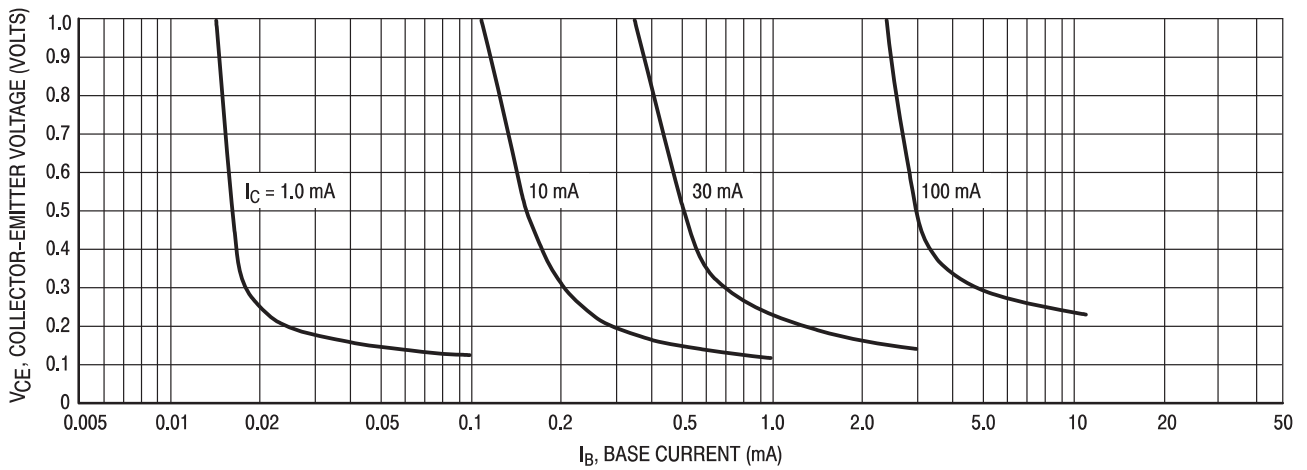

Figure 2. Collector Saturation Region

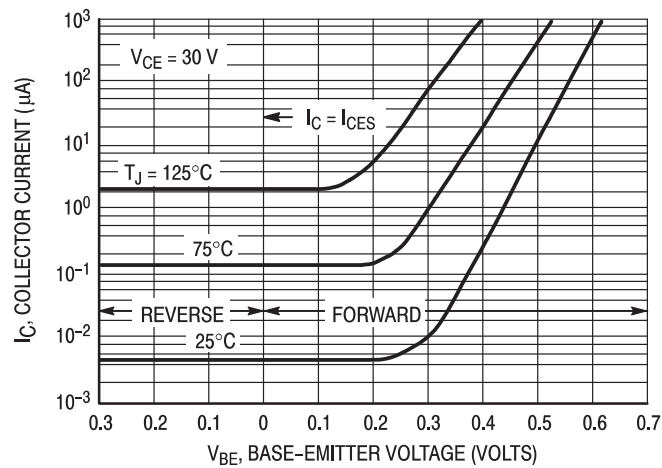

Figure 3. Collector Cut-Off Region



MMBT5401-AU

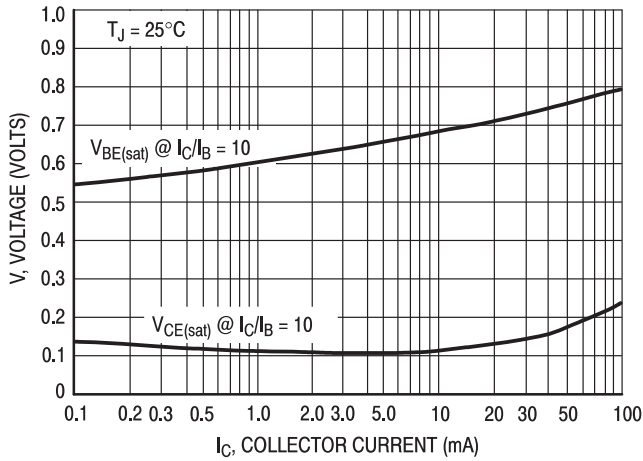

Figure 4. "On" Voltages

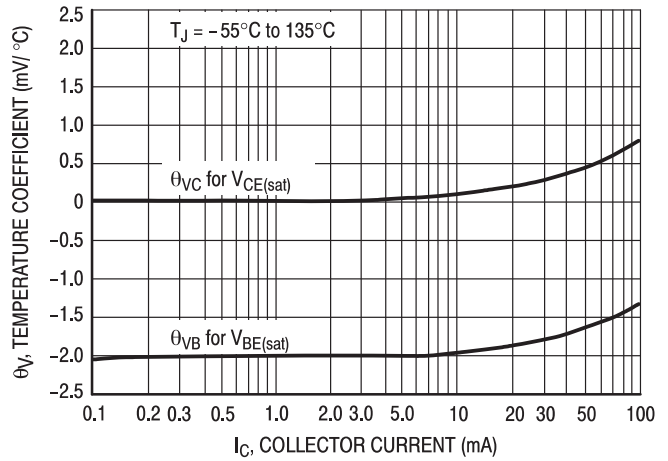

Figure 5. Temperature Coefficients

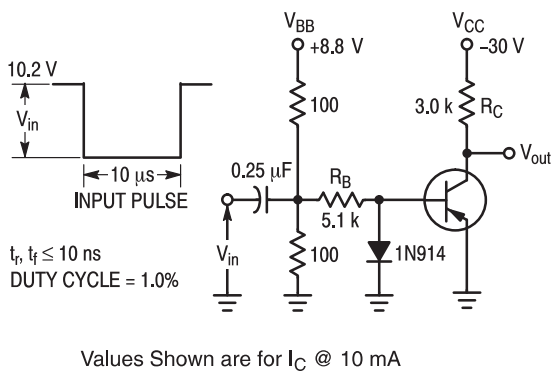

Figure 6. Switching Time Test Circuit

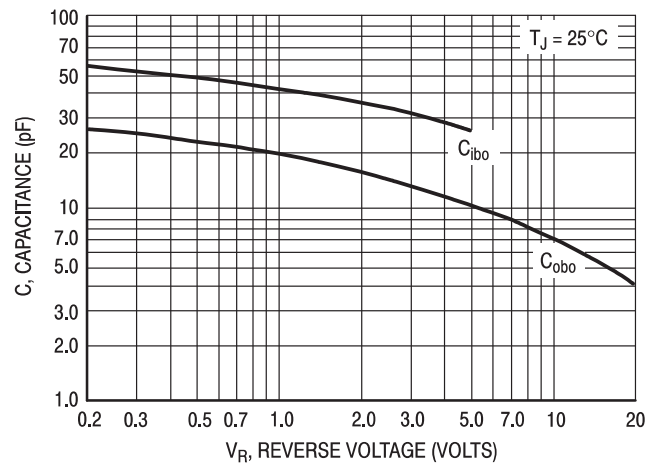

Figure 7. Capacitances

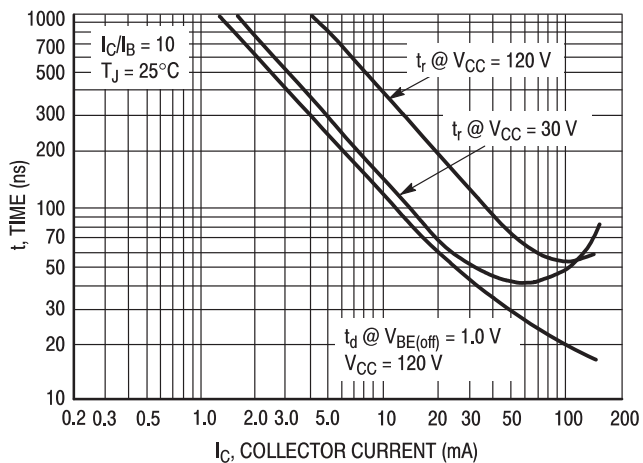

Figure 8. Turn-On Time

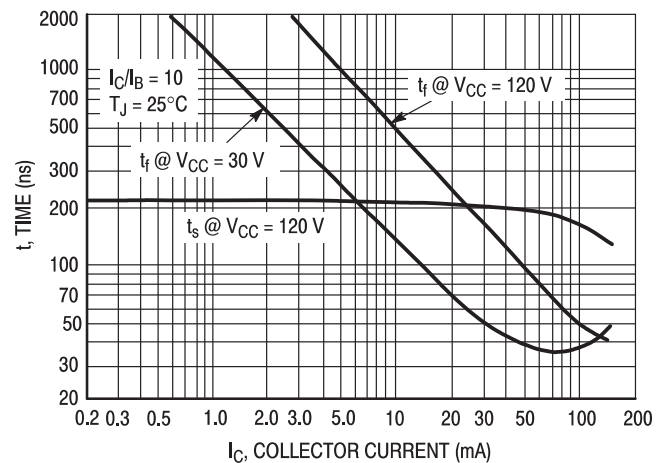
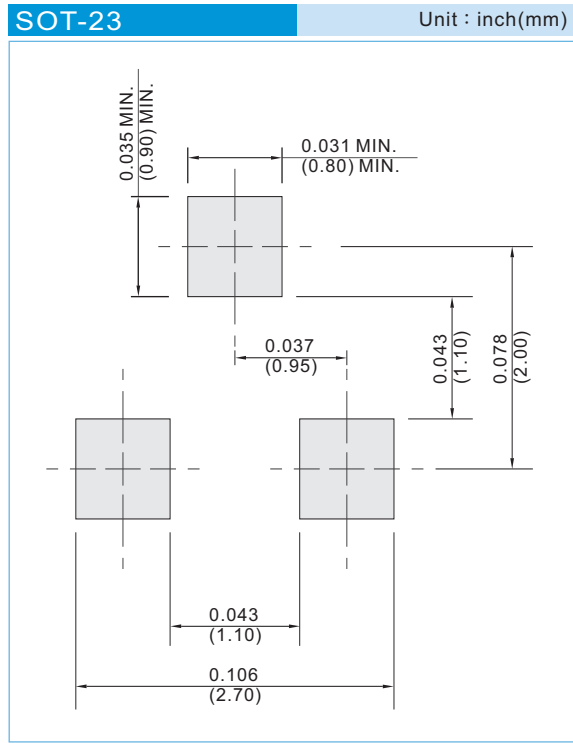

Figure 9. Turn-Off Time



MMBT5401-AU

MOUNTING PAD LAYOUT



ORDER INFORMATION

- Packing information
T/R - 12K per 13" plastic Reel
T/R - 3K per 7" plastic Reel



MMBT5401-AU

Part No._packing code_Version
MMBT5401-AU_R1_000A1

For example :

RB500V-40_R2_00001



Packing Code XX				Version Code XXXXX		
Packing type	1 st Code	Packing size code	2 nd Code	HF or RoHS	1 st Code	2 nd ~5 th Code
Tape and Ammunition Box (T/B)	A	N/A	0	HF	0	serial number
Tape and Reel (T/R)	R	7"	1	RoHS	1	serial number
Bulk Packing (B/P)	B	13"	2			
Tube Packing (T/P)	T	26mm	X			
Tape and Reel (Right Oriented) (TRR)	S	52mm	Y			
Tape and Reel (Left Oriented) (TRL)	L	PANASERT T/B CATHODE UP (PBCU)	U			
FORMING	F	PANASERT T/B CATHODE DOWN (PBCD)	D			



MMBT5401-AU

Disclaimer

- Reproducing and modifying information of the document is prohibited without permission from Panjit International Inc..
- Panjit International Inc. reserves the rights to make changes of the content herein the document anytime without notification. Please refer to our website for the latest document.
- Panjit International Inc. disclaims any and all liability arising out of the application or use of any product including damages incidentally and consequentially occurred.
- Panjit International Inc. does not assume any and all implied warranties, including warranties of fitness for particular purpose, non-infringement and merchantability.
- Applications shown on the herein document are examples of standard use and operation. Customers are responsible in comprehending the suitable use in particular applications. Panjit International Inc. makes no representation or warranty that such applications will be suitable for the specified use without further testing or modification.
- The products shown herein are not designed and authorized for equipments relating to human life and for any applications concerning life-saving or life-sustaining, such as medical instruments, aerospace machinery et cetera. Customers using or selling these products for use in such applications do so at their own risk and agree to fully indemnify Panjit International Inc. for any damages resulting from such improper use or sale.
- Since Panjit uses lot number as the tracking base, please provide the lot number for tracking when complaining.