



TABLE OF CONTENTS

1.DATA SHEET PAGE 1

2.MARKING PAGE 4

3.TAPING PAGE 5

4.PACKING PAGE 6

5.HIGH RELIABILITY SPEC. PAGE 11



RB751G-40

SURFACE MOUNT SCHOTTKY DIODES

VOLTAGE 40 Volts **CURRENT** 300 mA

SOD-723

Unit: inch (mm)

FEATURES

- Extremely Fast Switching Speed
- Very Low V_F : 0.325V (Typ) at $I_F = 1\text{mA}$
- Surface mount package ideally suited for automatic insertion
- In compliance with EU RoHS 2002/95/EC directives

MECHANICAL DATA

- Case: SOD-723, Plastic
- Terminals: Solderable per MIL-STD-750, Method 2026
- Appox Weight : 0.00077 gram
- Polarity : Color band cathode

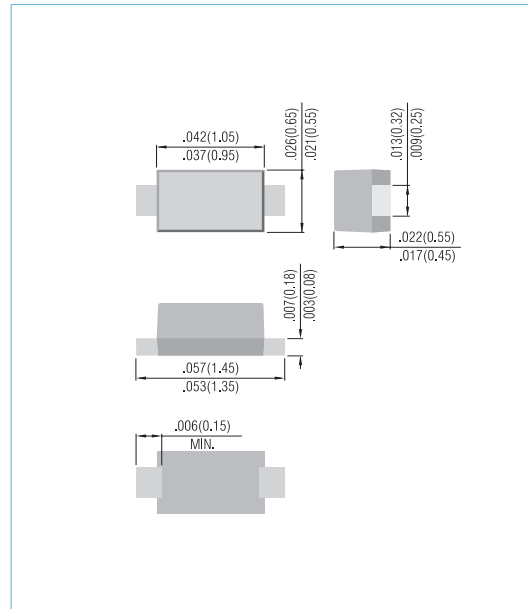

ABSOLUTE RATINGS

PARAMETER	Symbol	Value	Units
Marking	-	BC	-
Maximum Reverse DC Voltage	V_{RRM}	40	V
Peak Reverse Voltage	V_R	30	V
Maximum Forward Current	$I_{F(AV)}$	0.3	A
Non-repetitive Peak Forward Surge Current at $t=1000\text{ms}$	I_{FSM}	0.6	A
Power Dissipation ⁽¹⁾	P_{TOT}	200	mW
Thermal Resistance, Junction to Ambient ⁽¹⁾	$R_{\theta JA}$	635	$^{\circ}\text{C/W}$
Junction Temperature	T_J	-55 to 125	$^{\circ}\text{C}$
Storage Temperature	T_{STG}	-55 to 125	$^{\circ}\text{C}$



1. FR-4 Board = 70 x 60 x 1mm. Minmum Pad Layout



RB751G-40

ELECTRICAL CHARACTERISTICS ($T_J = 25^\circ\text{C}$ unless otherwise noted)

PARAMETER	Symbol	Test Condition	MIN.	TYP.	MAX.	Units
Reverse Leakage Current	I_R	$V_R=30\text{V}$	-	-	0.5	μA
Forward Voltage	V_F	$I_F=1\text{mA}$	-	-	0.37	V
Total Capacitance	C_J	$V_R=1\text{V}, F=1\text{MHz}$	-	-	2	pF

ELECTRICAL CHARACTERISTICS CURVE

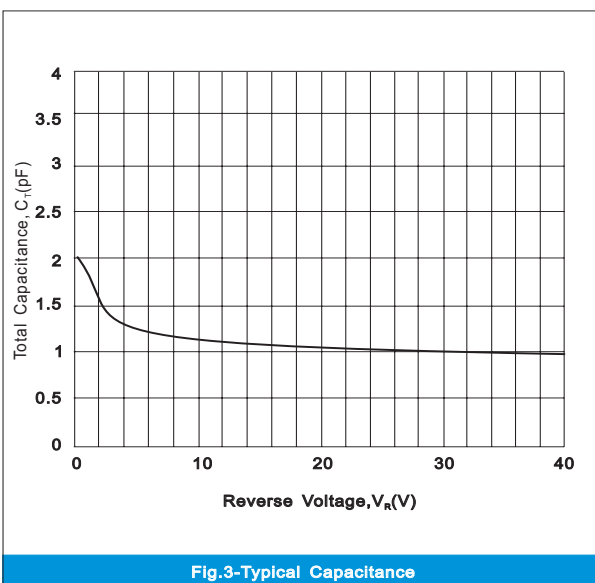
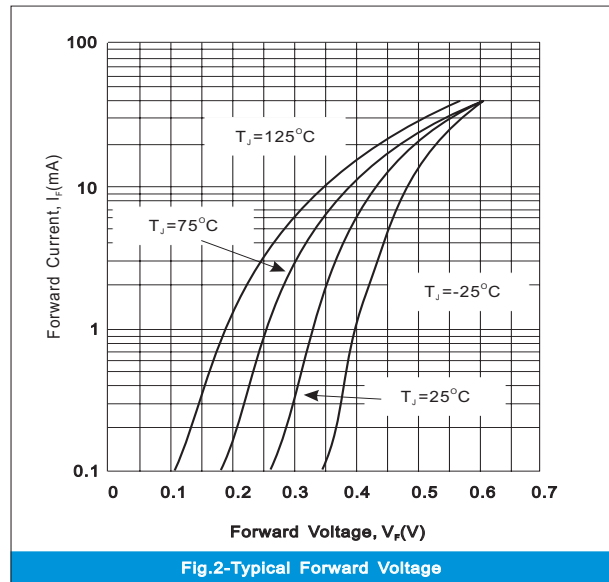
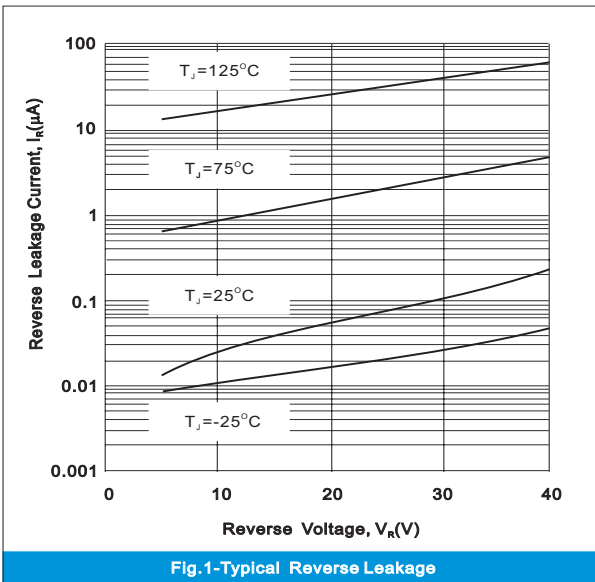



RB751G-40

MOUNTING PAD LAYOUT

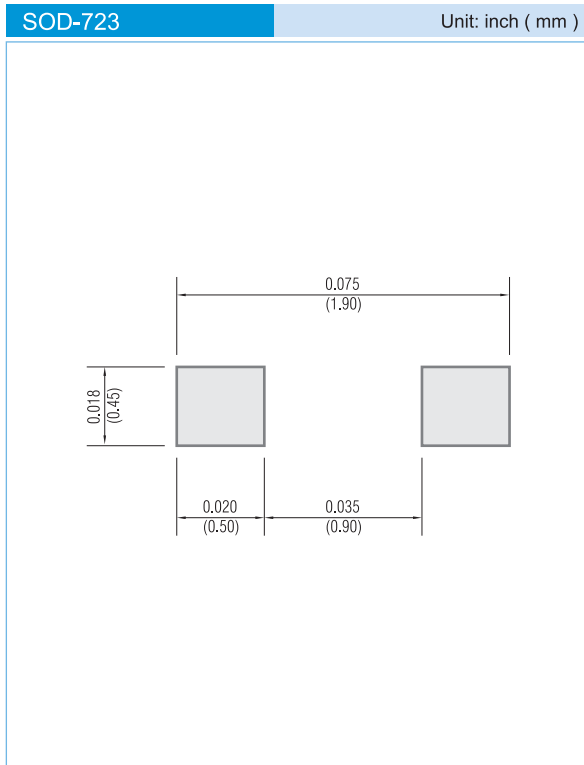

ORDER INFORMATION

- Packing information
T/R - 8K per 7" plastic Reel

LEGAL STATEMENT

Copyright PanJit International, Inc 2009

The information presented in this document is believed to be accurate and reliable. The specifications and information herein are subject to change without notice. Pan Jit makes no warranty, representation or guarantee regarding the suitability of its products for any particular purpose. Pan Jit products are not authorized for use in life support devices or systems. Pan Jit does not convey any license under its patent rights or rights of others.



2.MARKING

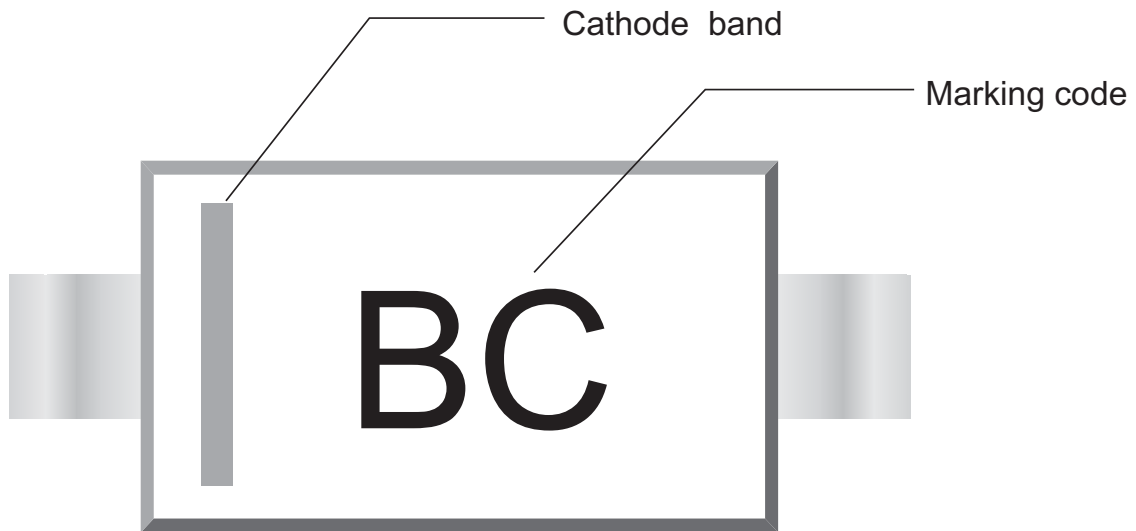



3. TAPING

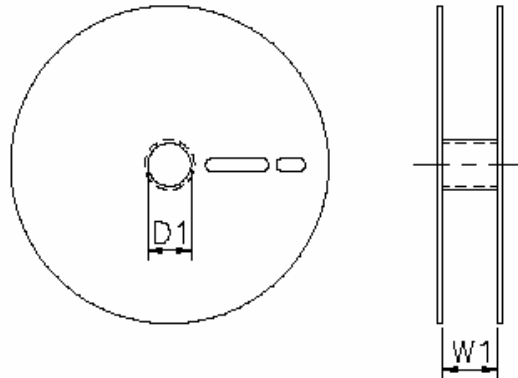

料號	D	D1	W1	長度	料名
23346	560.0±5	76.0±3	96.0±5	990M	SOD-723 CARRIER TAPE #3000

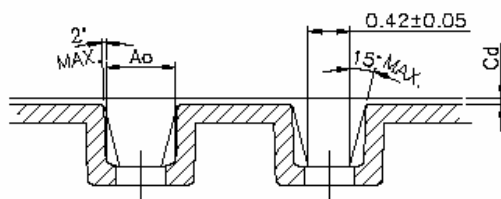
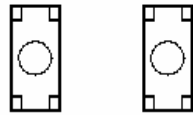
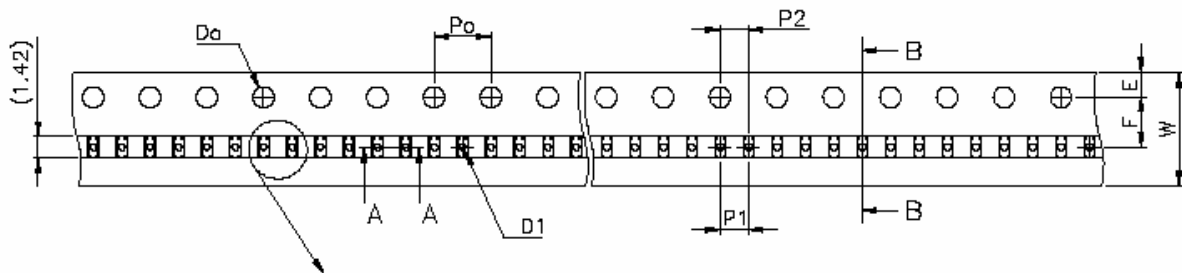

SECTION A-A

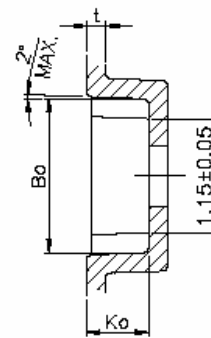

SECTION B-B

Ao	Bo	Ko	Po	P1	P2	t	E	F	Do	D1
0.72±0.05	1.55±0.05	0.58±0.05	4.0±0.10	2.0±0.05	2.0±0.05	0.19±0.02	1.75±0.10	3.50±0.05	∅1.50 ^{+0.10} ₋₀	∅0.50±0.05
W		Cd								
8.0 ^{+0.20} _{-0.10}		0.15 MAX.								



4. PACKING

REEL PACKING

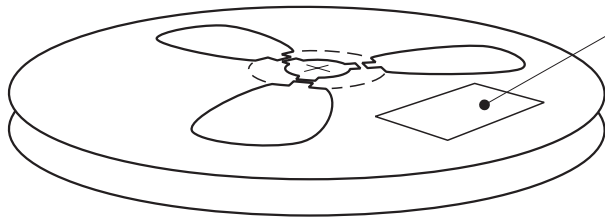

Quantity per Reel: 8,000 pcs

LABEL TYPE

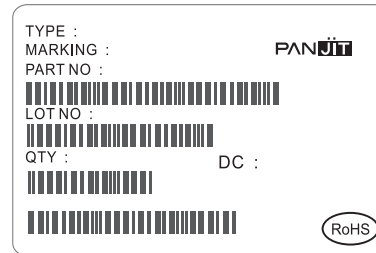

CARTON

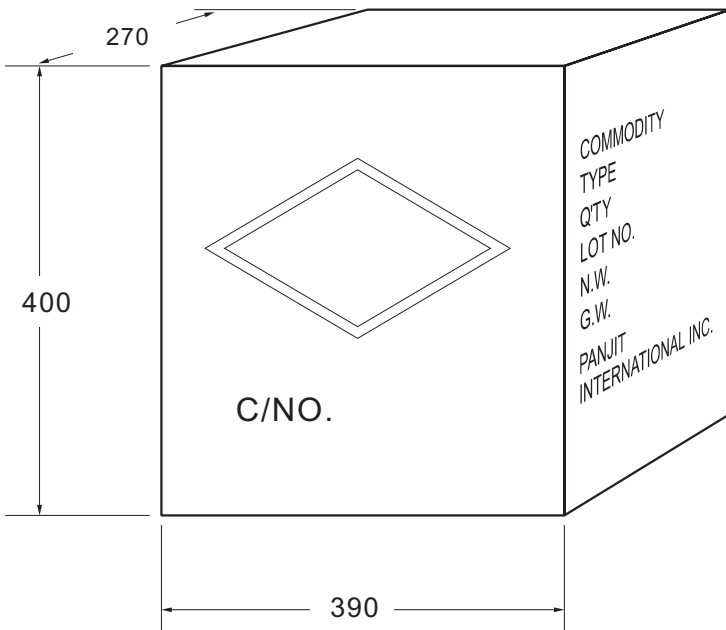

Box Dimensions : mm
Quantity per Box: 640,000pcs

SHIPPING MARK

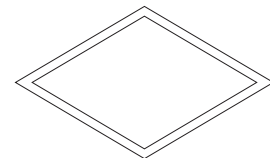

C/NO.
PRODUCT COUNTRY

SIDE MARK

COMMODITY:
TYPE:
Q'TY:
LOT NO.
N.W.
G.W.
PANJIT
INTERNATIONAL INC.



Bulk Packing

PACKAGE	INNER SIZE	BOX	CARTON SIZE	CARTON	APPROX. GROSS WEIGHT
	(m/m)	(EA)	(m/m)	(EA)	(Kg)
Bulk Packing					
A-405	198 x 84 x 20	1,000	459 x 214 x 256	50,000	12.7
AG / RB-10 (WOB)	258 x 190 x 77	1,000	395 x 270 x 400	10,000	15
AM	258 x 190 x 77	1,000	395 x 270 x 400	10,000	15
CM / KBPC	193 x 193 x 46	50	405 x 210 x 265	500	17
CMW / KBPC-W	193 x 193 x 46	50	405 x 210 x 265	500	17
KBPC-P /CP	193 x 193 x 46	50	405 x 210 x 265	500	9.5
KBPC-PW /CPW	193 x 193 x 46	50	405 x 210 x 265	500	9.5
CP-3 / 6 (K-3 / K-6)	219 x 115 x 90	200	600 x 235 x 198	2,000	7.3/8.8
CP-8 / 10 (K-8)	219 x 115 x 90	200	600 x 235 x 198	2,000	13.8
DIP	-	-	495 x 214 x 256	12,000	6.5
DO-15	200 x 85 x 25	1,000	459 x 214 x 256	40,000	20.7
DO-201AD	200 x 85 x 40	500	495 x 214 x 256	12,500	16
DO-201AE	200 x 85 x 40	500	495 x 214 x 256	12,500	16
DO-34	240 x 100 x 90	2,000	406 x 335 x 257	120,000	14.5
DO-35	240 x 100 x 90	2,000	406 x 335 x 257	120,000	17.1
DO-41	198 x 84 x 20	1,000	459 x 214 x 265	50,000	19.3
DO-41G	240 x 100 x 90	1,000	406 x 335 x 257	60,000	18.5
FL	230 x 230 x 50	500	495 x 245 x 180	3,000	18.4
GBJ (TUBE)	556 x 150 x 100	800	578 x 340 x 235	3,200	25.5
GBJ (BOX)	350 x 337 x 44	600	375 x 360 x 213	2,400	14.3
GBL	350 x 337 x 44	960	375 x 360 x 213	3,840	13.1
GBP	350 x 337 x 44	1,120	375 x 360 x 213	4,480	10.6
GBPC	193 x 193 x 46	50	405 x 210 x 265	500	17
GBPCW	193 x 193 x 46	50	405 x 210 x 265	500	17
GBU (TUBE)	488 x 150 x 100	800	510 x 310 x 235	3,200	22.6
GBU (BOX)	350 x 337 x 44	800	375 x 360 x 213	3,200	15.2
KBJ	220 x 176 x 45	200	375 x 230 x 260	2,000	15
KBPF	242 x 208 x 35	500	426 x 252 x 365	10,000	19.2
KBU	276 x 158 x 59	200	493 x 287 x 320	3,000	24
P-600	208 x 90 x 83	500	459 x 214 x 256	5,000	11.3
R-1	198 x 84 x 20	1,000	459 x 214 x 256	50,000	12.7
TO-220	540 x 145 x 85	2,000	555 x 306 x 200	8,000	20.5
ITO-220	540 x 145 x 85	2,000	555 x 306 x 200	8,000	22.9
TO-251AB	555 x 145 x 85	8,400	555 x 306 x 200	33,600	22
TO-3P / TO-247AD	-	-	536 x 243 x 100	1,500	13.9
TO-3PS / TO-247S	-	-	511 x 243 x 107	1,500	12.2



Reel Packing

PACKAGE	REEL SIZE	REEL	COMPONENT SPACE	TAPE SPACE	REEL DIA	CARTON SIZE	CARTON	APPROX. GROSS WEIGHT
	(inch)	(pcs)	(m/m)	(m/m)	(m/m)	(m/m)	(EA)	(Kg)
Reel Packing								
R-1	-	5,000	5.0	52	330	340 x 340 x 410	25,000	7.8
A-405	-	5,000	5.0	52	330	340 x 340 x 410	25,000	11
DO-15	-	4,000	5.0	52	330	340 x 340 x 410	20,000	11.4
DO-201AD	-	1,250	10.0	52	330	340 x 340 x 410	6,250	9.2
DO-201AE	-	1,250	10.0	52	330	340 x 340 x 410	6,250	9.2
DO-34	15	10,000	5.0	52	360	360 x 360 x 395	50,000	10.1
DO-35	15	10,000	5.0	52	360	360 x 360 x 395	50,000	11.2
DO-41	-	5,000	5.0	52	330	340 x 340 x 410	25,000	11.8
DO-41G	15	5,000	5.0	52	360	360 x 360 x 395	25,000	10.9
P-600	-	800	10.0	52	330	340 x 340 x 410	4,000	9.8
DPAK/TO-252	13	3,000	8.0	16	330	375 x 360 x 390	42,000	18.8
D2PAK/TO-263	13	800	16.0	24	330	375 x 360 x 390	6,400	14.4
MDI	13	3,000	8.0	12	330	375 x 360 x 390	48,000	14.7
SDIP	13	1,500	12.0	16	330	375 x 360 x 390	21,000	14.3
QUADRO-MELF	13	10,000	4.0	-	330	360 x 360 x 395	200,000	14.9
QUADRO-MELF	7	2,500	4.0	-	178	385 x 380 x 260	200,000	13.3
MELF/DL-41	13	5,000	4.0	-	330	360 x 360 x 395	100,000	23.5
MELF/DL-41	7	1,500	4.0	-	178	385 x 380 x 260	84,000	18.3
MICRO-MELF	13	10,000	4.0	-	330	360 x 360 x 395	200,000	11.5
MICRO-MELF	7	2,500	4.0	-	178	385 x 380 x 260	200,000	9.3
MINI-MELF	13	10,000	4.0	-	330	360 x 360 x 395	200,000	14.6
MINI-MELF	7	2500	4.0	-	178	385 x 380 x 260	200,000	12.7
SMA	13	7,500	4.0	12	330	375 x 360 x 390	120,000	17.3
SMA	7	1,800	4.0	12	178	390 x 240 x 420	72,000	10
SMB	13	3,000	8.0	12	330	375 x 360 x 390	48,000	13.2
SMB	7	500	8.0	12	178	390 x 240 x 420	20,000	6.5
SMC	13	3,000	8.0	16	330	375 x 360 x 390	42,000	18
SMC	7	500	8.0	16	178	390 x 240 x 420	15,000	8.3
SOD-123	13	10,000	4.0	8	330	375 x 360 x 213	120,000	6.5
SOD-123	7	3,000	4.0	8	178	390 x 270 x 400	240,000	9.9
SOD-123FL	13	10,000	4.0	8	330	375 x 360 x 213	120,000	7.2
SOD-123FL	7	3,000	4.0	8	178	390 x 270 x 400	240,000	10.6



Reel Packing

PACKAGE	REEL SIZE	REEL	COMPONENT SPACE	TAPE SPACE	REEL DIA	CARTON SIZE	CARTON	APPROX. GROSS WEIGHT
	(inch)	(pcs)	(m/m)	(m/m)	(m/m)	(m/m)	(EA)	(Kg)
Reel Packing								
SOD-323	13	12,000	4.0	8	330	375 x 360 x 213	144,000	5.9
SOD-323	7	5,000	4.0	8	178	390 x 270 x 400	400,000	9.4
SOD-523	13	12,000	4.0	8	330	375 x 360 x 213	144,000	5.4
SOD-523	7	5,000	4.0	8	178	390 x 270 x 400	400,000	9.1
SOD-723	7	8,000	2.0	8	178	390 x 270 x 400	640,000	8.5
SOD-923	7	8,000	2.0	8	178	390 x 270 x 400	640,000	7.7
SOT-23	13	12,000	4.0	8	330	375 x 360 x 213	144,000	7
SOT-23	7	3,000	4.0	8	178	390 x 270 x 400	240,000	8.3
SOT-323	13	12,000	4.0	8	330	375 x 360 x 213	144,000	6.1
SOT-323	7	3,000	4.0	8	178	390 x 270 x 400	240,000	7.9
SOT-363	13	10,000	4.0	8	330	375 x 360 x 213	120,000	7.1
SOT-363	7	3,000	4.0	8	178	390 x 270 x 400	240,000	10.2
SOT-23 (ESD)	7	3,000	4.0	8	178	455 x 270 x 440	240,000	9.5
SOT-323 (ESD)	7	3,000	4.0	8	178	455 x 270 x 440	240,000	9.1
SOT-363 (ESD)	7	3,000	4.0	8	178	455 x 270 x 440	240,000	10
SOT-353	13	10,000	4.0	8	330	375 x 360 x 213	120,000	7.2
SOT-353	7	3,000	4.0	8	178	390 x 270 x 400	240,000	10
SOT-553	13	10,000	4.0	8	330	375 x 360 x 213	120,000	5.2
SOT-553	7	4,000	4.0	8	178	390 x 270 x 400	320,000	9.4
SOT-563	13	10,000	4.0	8	330	375 x 360 x 213	120,000	5.2
SOT-563	7	4,000	4.0	8	178	390 x 270 x 400	320,000	9.4
SOT23-5L	13	10,000	4.0	8	330	375 x 360 x 213	120,000	7.9
SOT23-5L	7	3,000	4.0	8	178	390 x 270 x 400	240,000	14.5
SOT23-6L	13	10,000	4.0	8	330	375 x 360 x 213	120,000	7.9
SOT23-6L	7	3,000	4.0	8	178	390 x 270 x 400	240,000	14.5
SOT-143	13	10,000	4.0	8	330	375 x 360 x 213	120,000	7
SOT-143	7	3,000	4.0	8	178	390 x 270 x 400	240,000	12.8
SOIC-08	13	3,000	8.0	12	330	375 x 360 x 213	48,000	14.2
QFN 1.2 x 1.5	7	3,000	4.0	8	178	390 x 270 x 400	240,000	7.1
QFN 1.6 x 1.6	7	4,000	4.0	8	178	390 x 240 x 420	200,000	7.8
QFN 2.0 x 2.0	7	3,000	4.0	8	178	390 x 270 x 400	240,000	7.1



Ammunition Packing

PACKAGE	AMMO	COMPONENT SPACE	TAPE SPACE	BOX SIZE	CARTON	CARTON	APPROX. GROSS WEIGHT
	(PCS)	(m/m)	(m/m)	(m/m)	(m/m)	(E/A)	(Kg)
Ammunition Packing							
A-405	5,000	5	26	255 x 47 x 150	339 x 276 x 330	60,000	12.4
A-405	5,000	5	52	255 x 75 x 150	339 x 276 x 330	40,000	16
DO-15	3,000	5	52	255 x 75 x 150	339 x 276 x 330	24,000	13.3
DO-201AD	1,250	10	52	255 x 47 x 122	339 x 276 x 330	10,000	13.4
DO-201AE	1,250	10	52	255 x 47 x 122	339 x 276 x 330	10,000	13.4
DO-34	5,000	5	26	248 x 80 x 48	406 x 335 x 257	150,000	14.6
DO-34	5,000	5	52	248 x 80 x 75	406 x 335 x 257	100,000	12.7
DO-35	5,000	5	26	248 x 80 x 48	406 x 335 x 257	150,000	16.7
DO-35	5,000	5	52	248 x 80 x 75	406 x 335 x 257	100,000	15.2
DO-41	5,000	5	52	255 x 75 x 150	339 x 276 x 330	40,000	16
DO-41G	2,500	5	26	248 x 80 x 48	406 x 335 x 257	75,000	17.1
DO-41G	2,500	5	52	248 x 80 x 75	406 x 335 x 257	50,000	15.7
P-600	400	10	52	255 x 47 x 122	339 x 276 x 330	3,200	8.1
R-1	3,000	5	26	255 x 47 x 73	310 x 268 x 170	36,000	6.3
R-1	3,000	5	52	256 x 73 x 73	310 x 268 x 170	24,000	6.4
R-1	5,000	5	52	255 x 73 x 122	339 x 276 x 274	40,000	10.3



5. HIGH RELIABILITY TESTING SPEC.

NO	TEST ITEM	TEST CONDITION	REFERENCE DOCUMENT	LOT QUALITY LEVEL	REMARK
1	TEMPERATURE CYCLING (T.C.T)	Ta = -55 + 0, -3 °C 10min Ta = + 150 + / - °C 10min FOR 20 CYCLE	MIL-STD-750D METHOD-1051.5	LTPD 10 S.s. = 22 ACCEPT FOR 0 FAILURE ONLY.	
2	HIGH TEMPERATURE STORAGE LIFE (H.T.S.L)	Ta = 150 + / - 5 °C TESTING TIME: 168 HRS 500 HRS	MIL-STD-750D METHOD-1031.2	LTPD10 S.s. = 22 ACCEPT FOR 0 FAILURE ONLY.	
3	SOLDERABILITY TEST	TEMPERATURE OF SOLDER POT = 245 + / - 5 °C TIME FOR DIPPING FLUX = 5 -10 SEC TIME FOR DIPPING IN SOLDER = 5 + / - 0.5 SEC DIPPING DEPTH = 0.05 inch max FOR ONE CYCLE	MIL-STD-750D	METHOD-2026.10 LTPD 7 S.s. = 32 ACCEPT FOR 0 FAILURE ONLY.	
4	HIGH TEMPERATURE REVERSE BIAS (H.T.R.B)	Ta = 150 + / - 5 °C VR = 80 % VR (CUSTOM SECP) TESTING TIME: 168 HRS 500 HRS	MIL-STD-750D METHOD-1038.3	LTPD10 S.s. = 22 ACCEPT FOR 0 FAILURE ONLY.	
5	CONTINUE FORWARD OPERATING LIFE (C.F.O.L)	Ta = 55 °C I = IO + / -10 % TESTING TIME: 168 HRS 500 HRS	MIL-STD-750D METHOD-1027.3	LTPD10 S.s. = 22 ACCEPT FOR 0 FAILURE ONLY.	
6	THERMAL SHOCK (T.S.T)	HOT TANK T = 100 °C + 10 / -2 °C t = 5 min COLD TANK T = 0 °C + 2 / -10 °C t = 5 min 15 CYCLE TIME BETWEEN TRANSFERRING DO'NOT EXCEED 10 SECOND.	MIL-STD-750D METHOD-1056.7	LTPD10 S.s. = 22 ACCEPT FOR 0 FAILURE ONLY.	
7	PRESSURE COOKER (P.C.T)	Ta = 121 °C P = 1.2 kg / cm ² TIME = 96 HRS	JEDEC JESD22-A102-C	LTPD10 S.s. = 22 ACCEPT FOR 0 FAILURE ONLY.	
8	INTERMITTENT FORWARD OPERATING LIFE (I.F.O.L)	I = Io x 1.0 POWER ON : 30 SEC POWER OFF : 50 SEC TESTING TIME: 2000 CYCLES	MIL-STD-750D METHOD 1036.3	LTPD10 S.s. = 22 ACCEPT FOR 0 FAILURE ONLY.	
9	FORWARD SURGE CURRENT (I.F.S.M)	SQ WAVE OR SINE WAVE IFSM=DATE SHEET SPEC. TIME = 8.3 Msec T = 1 CYCLE	MIL-STD-750D METHOD 4066.3	LTPD10 S.s. = 22 ACCEPT FOR 0 FAILURE ONLY.	
10	HUMIDITY	Ta = 85 °C RH = 85 % TESTING TIME: 168 HRS 500 HRS	MIL-STD-750D METHOD 1021.1	LTPD10 S.s. = 22 ACCEPT FOR 0 FAILURE ONLY.	
11	SOLDERABILITY RESISTANCE	TEMPERATURE OF SOLDER POT = 260 + / -5 °C TIME FOR DIPPING IN SOLDER = 10 + 2 / -0 SEC DIPPING DEPTH = 1.57 + / 0.79 mm BELOW BODY FOR ONE CYCLE	MIL-STD-750D METHOD 2031.1	LTPD10 S.s. = 22 ACCEPT FOR 0 FAILURE ONLY.	

SCHOTTKY PRODUCT TESTING TEMPERATURE 100 °C +/- 5°C MAX(NORMAL)